

# Cascadable Silicon Bipolar MMIC Amplifier

## Technical Data

### MSA-0400

#### Features

- **Cascadable 50 Ω Gain Block**
- **3 dB Bandwidth:**  
DC to 4.0 GHz
- **8.5 dB Typical Gain at  
1.0 GHz**
- **16.0 dBm Typical P<sub>1 dB</sub> at  
1.0 GHz**

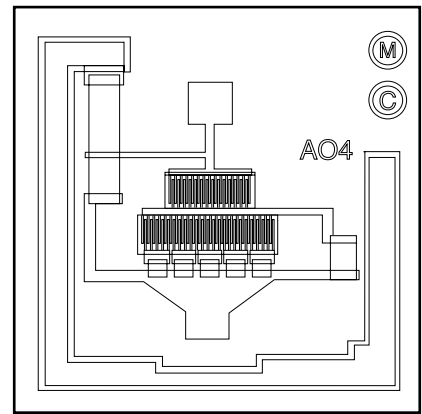
#### Description

The MSA-0400 is a high performance silicon bipolar Monolithic Microwave Integrated Circuit (MMIC) chip. This MMIC is designed for use as a general purpose 50 Ω gain block. Typical applications include narrow and broad band IF and RF amplifiers in commercial, industrial and military applications.

The MSA-series is fabricated using HP's 10 GHz f<sub>T</sub>, 25 GHz f<sub>MAX</sub>, silicon bipolar MMIC process which uses nitride self-alignment, ion implantation, and gold metallization to achieve excellent performance, uniformity and reliability. The use of an external bias resistor for temperature and current stability also allows bias flexibility.

The recommended assembly procedure is gold-eutectic die attach at 400°C and either wedge or ball bonding using 0.7 mil gold wire. See APPLICATIONS section, "Chip Use".

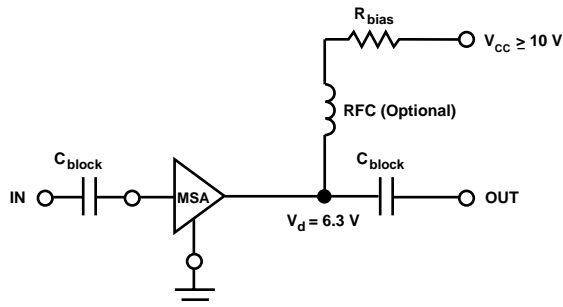
#### Chip Outline<sup>[1]</sup>



#### Note:

1. Refer to the APPLICATIONS section "Silicon MMIC Chip Use" for additional information.

#### Typical Biasing Configuration



## MSA-0400 Absolute Maximum Ratings

Parameter	Absolute Maximum <sup>[1]</sup>
Device Current	120 mA
Power Dissipation <sup>[2,3]</sup>	850 mW
RF Input Power	+13 dBm
Junction Temperature	200°C
Storage Temperature	-65 to 200°C

### Thermal Resistance<sup>[2,4]:</sup>

$$\theta_{jc} = 35^{\circ}\text{C/W}$$

#### Notes:

1. Permanent damage may occur if any of these limits are exceeded.
2.  $T_{\text{Mounting Surface}} (T_{\text{MS}}) = 25^{\circ}\text{C}$ .
3. Derate at 28.6 mW/°C for  $T_{\text{MS}} > 170^{\circ}\text{C}$ .
4. The small spot size of this technique results in a higher, though more accurate determination of  $\theta_{jc}$  than do alternate methods. See MEASUREMENTS section "Thermal Resistance" for more information.

## Part Number Ordering Information

Part Number	Devices Per Tray
MSA-0400-GP4	100

## Electrical Specifications<sup>[1]</sup>, $T_A = 25^{\circ}\text{C}$

Symbol	Parameters and Test Conditions <sup>[2]:</sup> $I_d = 90 \text{ mA}$ , $Z_0 = 50 \Omega$	Units	Min.	Typ.	Max.
$G_P$	Power Gain ( $ S_{21} ^2$ ) $f = 0.1 \text{ GHz}$	dB		8.5	
$\Delta G_P$	Gain Flatness $f = 0.1 \text{ to } 2.5 \text{ GHz}$	dB		$\pm 0.6$	
$f_{3 \text{ dB}}$	3 dB Bandwidth	GHz		4.3	
VSWR	Input VSWR $f = 0.1 \text{ to } 2.5 \text{ GHz}$			1.7:1	
	Output VSWR $f = 0.1 \text{ to } 2.5 \text{ GHz}$			1.8:1	
NF	50 $\Omega$ Noise Figure $f = 1.0 \text{ GHz}$	dB		6.5	
$P_1 \text{ dB}$	Output Power at 1 dB Gain Compression $f = 1.0 \text{ GHz}$ , $I_d = 50 \text{ mA}$	dBm		12.5	
	Output Power at 1 dB Gain Compression $f = 1.0 \text{ GHz}$ , $I_d = 90 \text{ mA}$	dBm		16.0	
$IP_3$	Third Order Intercept Point $f = 1.0 \text{ GHz}$	dBm		30.0	
$t_D$	Group Delay $f = 1.0 \text{ GHz}$	psec		140	
$V_d$	Device Voltage	V	5.7	6.3	6.9
$dV/dT$	Device Voltage Temperature Coefficient	mV/°C		-8.0	

#### Notes:

1. The recommended operating current range for this device is 40 to 110 mA. Typical performance as a function of current is on the following page.
2. RF performance of the chip is determined by packaging and testing 10 devices per wafer in a dual ground configuration.

## Typical Scattering Parameters<sup>[1]</sup> ( $Z_0 = 50 \Omega$ , $T_A = 25^{\circ}\text{C}$ , $I_d = 50 \text{ mA}$ )

Freq. GHz	$S_{11}$		$S_{21}$			$S_{12}$			$S_{22}$		k
	Mag	Ang	dB	Mag	Ang	dB	Mag	Ang	Mag	Ang	
0.1	.18	179	8.6	2.68	177	-16.4	.151	1	.10	-13	1.37
0.5	.18	-179	8.6	2.68	163	-16.3	.153	7	.16	-54	1.34
1.0	.16	-171	8.5	2.65	145	-15.8	.161	10	.22	-83	1.28
1.5	.16	-161	8.4	2.63	127	-15.4	.169	16	.29	-101	1.19
2.0	.21	-156	8.2	2.56	109	-14.6	.187	18	.33	-119	1.07
2.5	.27	-152	7.8	2.45	98	-13.8	.205	24	.37	-128	0.98
3.0	.33	-159	7.0	2.23	82	-13.4	.213	24	.42	-140	0.91
4.0	.42	-171	5.2	1.81	54	-12.5	.237	21	.42	-151	0.86
5.0	.45	172	3.4	1.49	3	-11.7	.259	17	.38	-153	0.94

#### Note:

1. S-parameters are de-embedded from 70 mil package measured data using the package model found in the DEVICE MODELS section.

### MSA-0400 Typical Scattering Parameters<sup>[1]</sup> ( $Z_0 = 50 \Omega$ , $T_A = 25^\circ\text{C}$ , $I_d = 90 \text{ mA}$ )

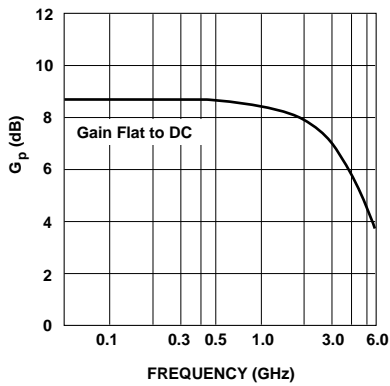
Freq. GHz	S <sub>11</sub>		S <sub>21</sub>			S <sub>12</sub>			S <sub>22</sub>		k
	Mag	Ang	dB	Mag	Ang	dB	Mag	Ang	Mag	Ang	
0.1	.25	179	8.7	2.73	177	-16.4	.152	2	.03	-36	1.33
0.5	.24	173	8.8	2.76	164	-16.3	.153	5	.10	-83	1.31
1.0	.22	166	8.8	2.74	148	-15.9	.160	10	.19	-91	1.26
1.5	.16	164	8.8	2.74	132	-15.3	.172	16	.27	-94	1.18
2.0	.13	173	8.7	2.73	116	-14.5	.189	22	.32	-98	1.10
2.5	.12	-162	8.3	2.60	106	-13.9	.203	31	.36	-95	1.04
3.0	.14	-147	8.0	2.50	90	-13.1	.222	33	.40	-95	0.97
4.0	.17	-154	6.7	2.17	64	-10.9	.286	36	.43	-93	0.87
5.0	.20	146	5.2	1.83	41	-9.2	.346	36	.40	-94	0.89

**Note:**

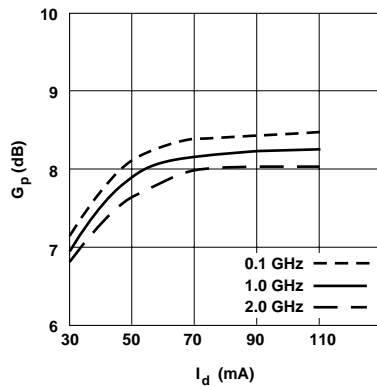
- S-parameters are de-embedded from 200 mil BeO package measured data using the package model found in the DEVICE MODELS section.

### Typical Performance, $T_A = 25^\circ\text{C}$

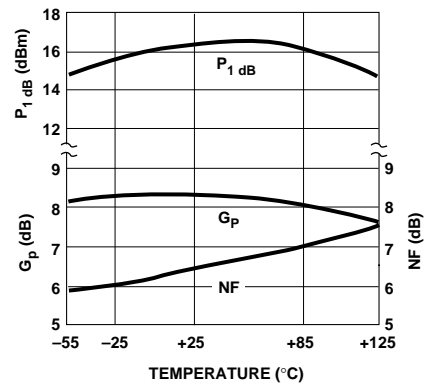
(unless otherwise noted)



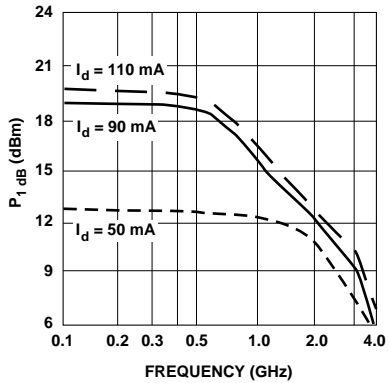
**Figure 1. Typical Power Gain vs. Frequency,  $T_A = 25^\circ\text{C}$ ,  $I_d = 90 \text{ mA}$ .**



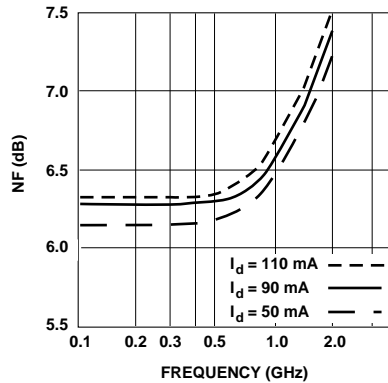
**Figure 2. Power Gain vs. Current.**



**Figure 3. Output Power at 1 dB Gain Compression, NF and Power Gain vs. Mounting Surface Temperature,  $f=1.0 \text{ GHz}$ ,  $I_d=90\text{mA}$ .**

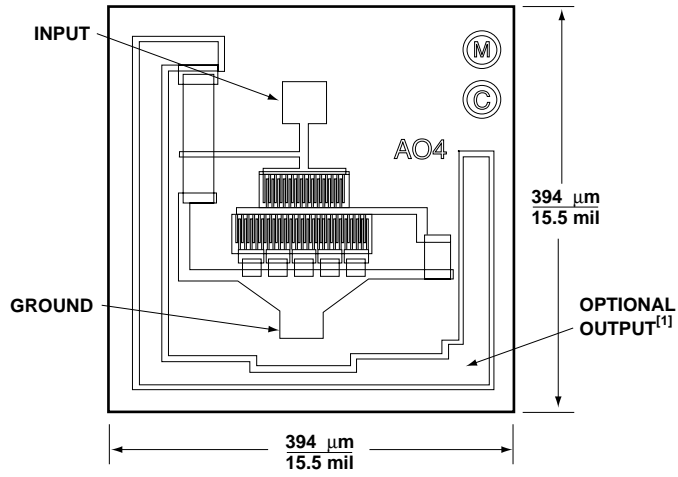


**Figure 4. Output Power at 1 dB Gain Compression vs. Frequency.**



**Figure 5. Noise Figure vs. Frequency.**

## MSA-0400 Chip Dimensions



Unless otherwise specified, tolerances are  $\pm 13 \mu\text{m}/\pm 0.5 \text{ mils}$ . Chip thickness is  $114 \mu\text{m}/4.5 \text{ mil}$ . Bond Pads are  $41 \mu\text{m}/1.6 \text{ mil}$  typical on each side. Note 1: Output contact is made by die attaching the backside of the die.