

# FMM5059VF

## Ku Band Power Amplifier MMIC

### FEATURES

- High Output Power: 35.0dBm(typ.)
- High Linear Gain: 29.0dB(typ.)
- Low Input VSWR
- Broad Band: 13.75-14.5GHz
- Impedance Matched  $Z_{in}/Z_{out} = 50\Omega$
- Small Hermetic Metal-Ceramic Package(VF-pkg)

### DESCRIPTION

The FMM5059VF is a MMIC amplifier that contains a three-stage amplifier, internally matched, for standard communications in the 13.75 to 14.5GHz frequency range. This product is well suited for VSAT applications as it offers high power, high gain, and low VSWR.

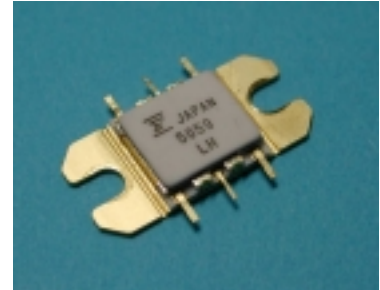

Eudyna's stringent Quality Assurance Program assures the highest reliability and consistent performance.

### ABSOLUTE MAXIMUM RATING

Item	Symbol	Rating	Unit
DC Input Voltage	VDD	+10	V
DC Input Voltage	VGG	-3	V
Input Power	P <sub>in</sub>	+26	dBm
Storage Temperature	T <sub>stg</sub>	-55 to +125	°C

### RECOMMENDED OPERATING CONDITION

Item	Symbol	Condition	Unit
DC Input Voltage	VDD	<=8	V
Operating Case Temperature	T <sub>c</sub>	-40 to +85	°C

### ELECTRICAL CHARACTERISTICS (Case Temperature T<sub>c</sub>=25°C)

Item	Symbol	Condition	Limit			Unit	
			Min.	Typ.	Max.		
Gate Bias Voltage	VGG(DC)		-0.50	-0.25	-0.01	V	
Output Power at 1dB G.C.P.	P <sub>1dB</sub>	VDD=7V IDD=1300mA(typ.) f=13.75-14.50GHz	34.0	35.0	-	dBm	
Power Gain at 1dB G.C.P.	G <sub>1dB</sub>		26.0	28.0	-	dB	
Drain Current at P <sub>1dB</sub>	IDD(RF)		-	1600	1900	mA	
Power Added Efficiency at P <sub>1dB</sub>	$\eta_{add}$		-	28	-	%	
Gain Flatness	$\Delta G$			-	1.5	2.0	dB
Input Return Loss	RL <sub>in</sub>		P <sub>in</sub> <-5dBm	-	-10	-6	dB
Output Return Loss	RL <sub>out</sub>	-		-14	-8	dB	
Intermodulation Distortion	IM <sub>3</sub>	$\Delta f=10MHz$ 2-Tone Test P <sub>out</sub> =25.5dBm S.C.L.	-26	-29	-	dBc	

G.C.P.:Gain Compression Point

S.C.L.:Single Carrire Level

ESD	Class 0	~ 199V
-----	---------	--------

Note : Based on EIAJ ED-4701 C-111A(C=100pF, R=1.5k $\Omega$ )

CASE STYLE	VF
------------	----

# FMM5059VF

## Ku band Power Amplifier MMIC

OUTPUT POWER vs. FREQUENCY

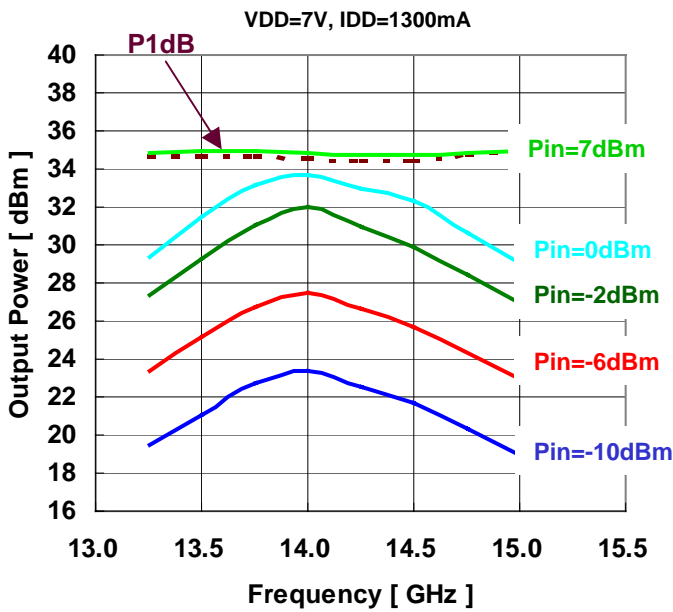

OUTPUT POWER, IDD vs. INPUT POWER

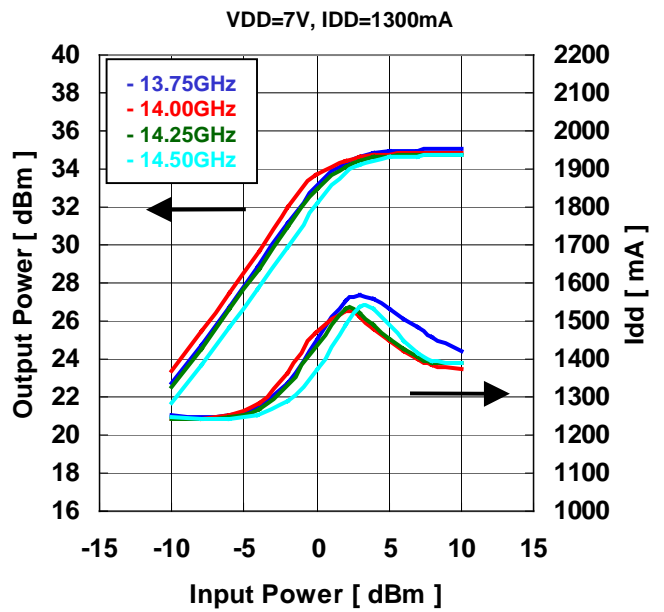

POWER ADDED EFFICIENCY vs FREQUENCY

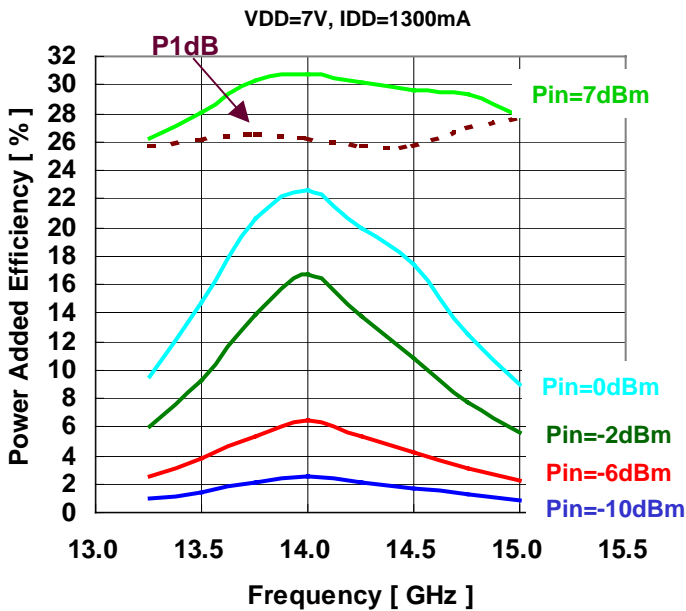

IMD vs TOTAL OUTPUT POWER

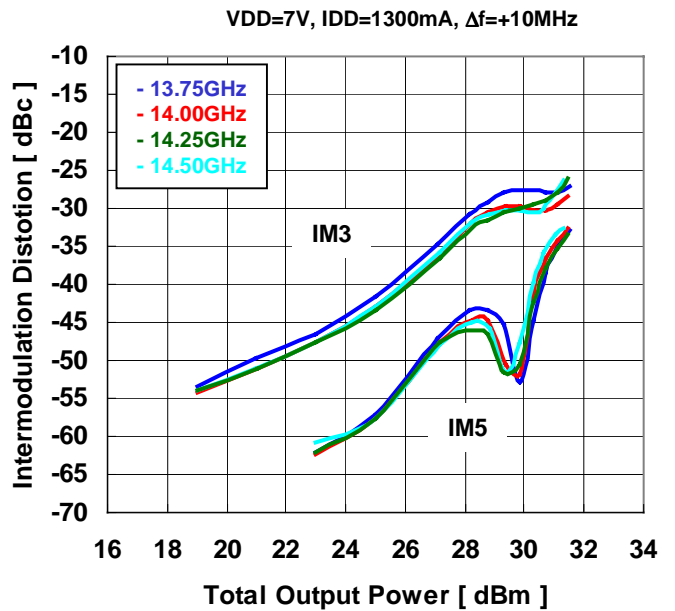

# FMM5059VF

## Ku band Power Amplifier MMIC

OUTPUT POWER, DRAIN CURRENT vs. INPUT POWER by Drain Voltage

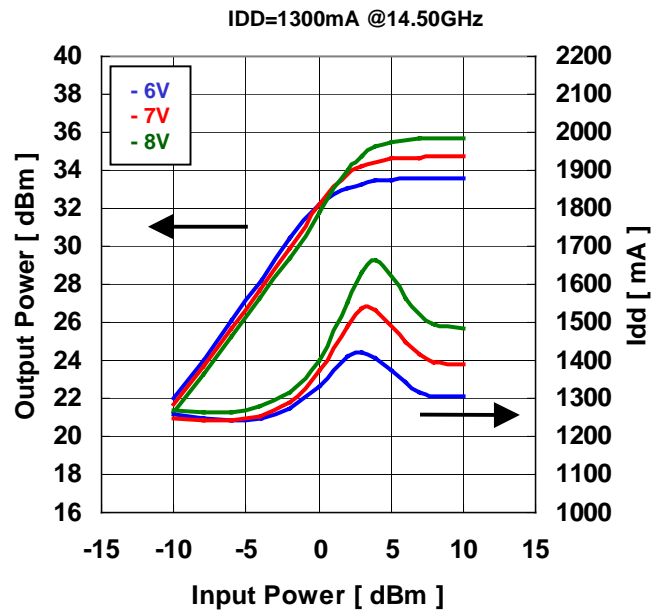
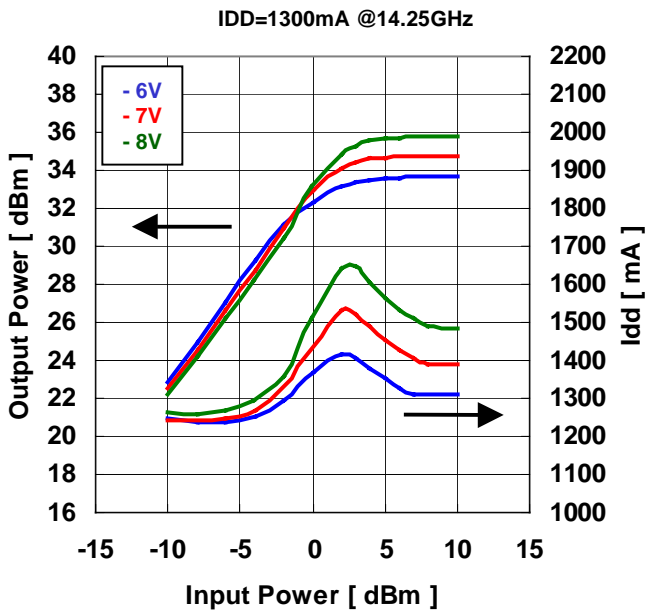
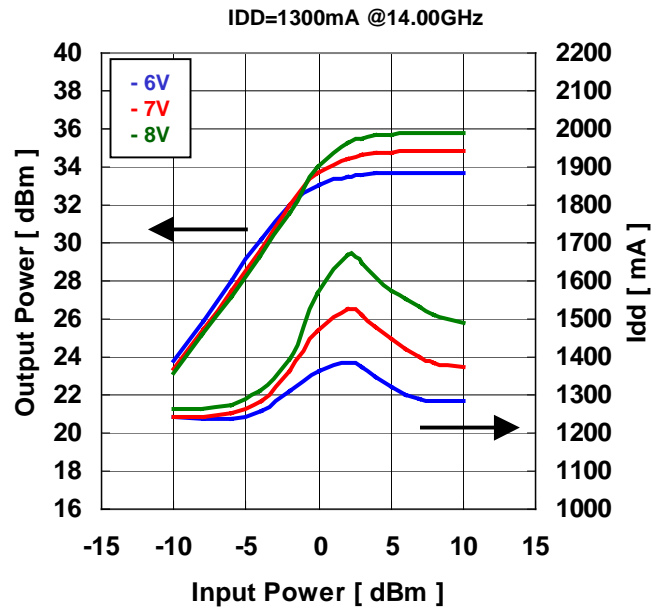
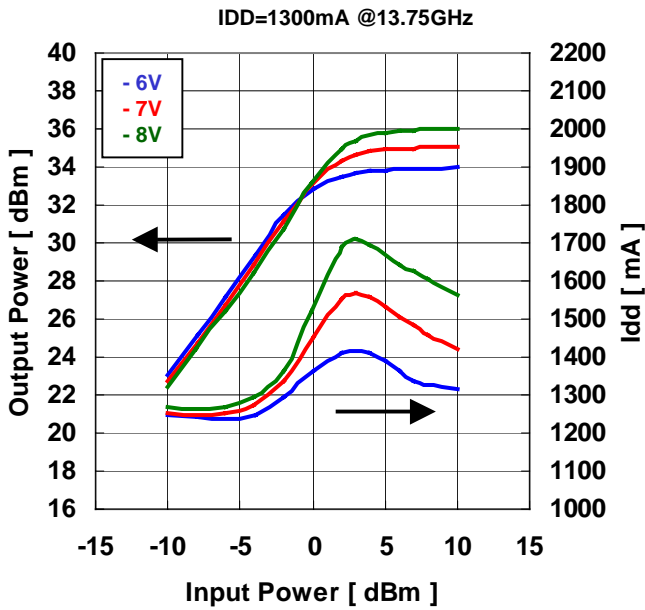

# FMM5059VF

## Ku band Power Amplifier MMIC

OUTPUT POWER, DRAIN CURRENT vs. INPUT POWER by Drain Current

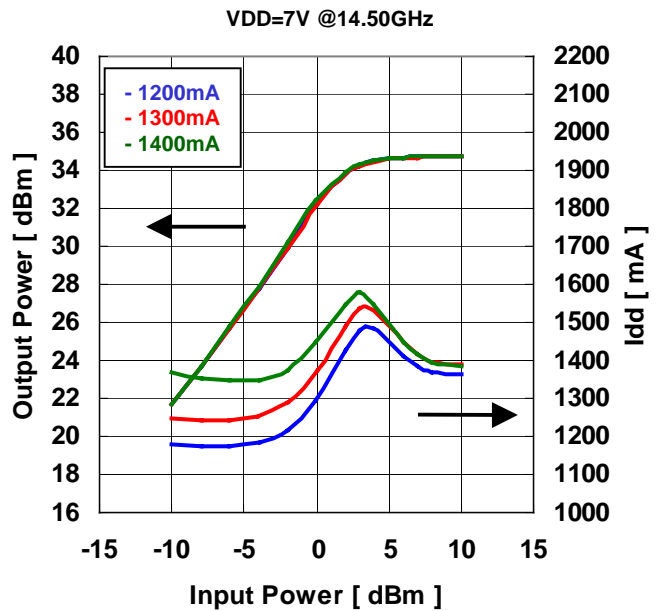
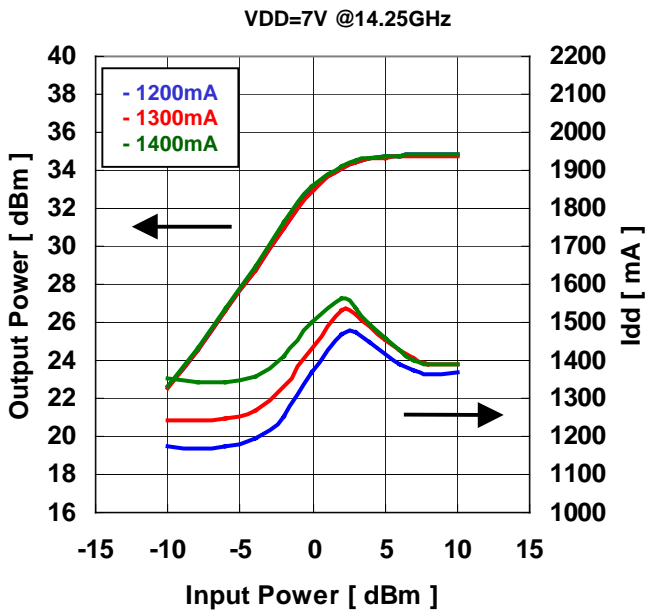
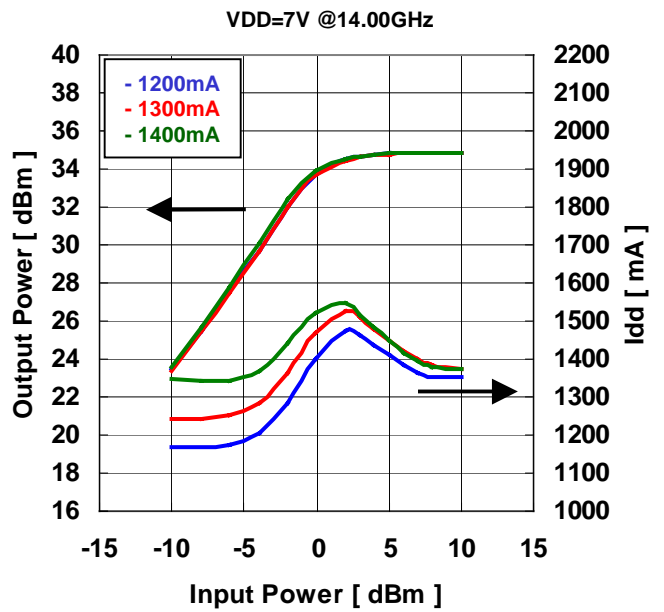
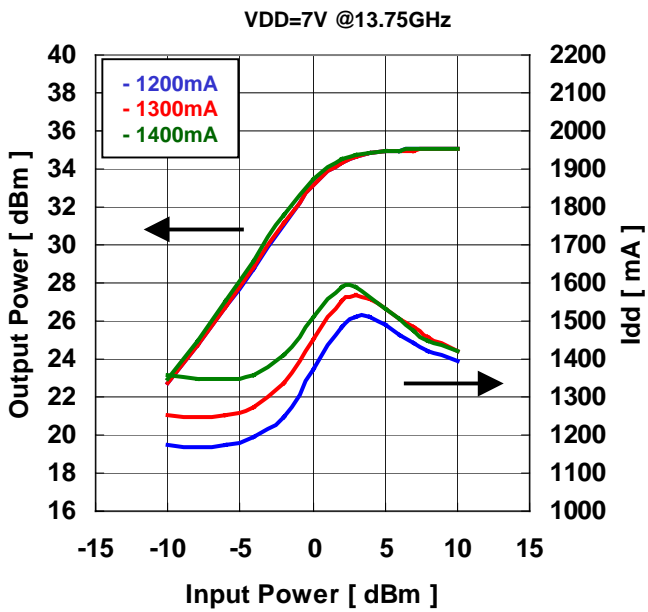

# FMM5059VF

## Ku band Power Amplifier MMIC

### IMD PERFORMANCE vs OUTPUT POWER by Drain Voltage

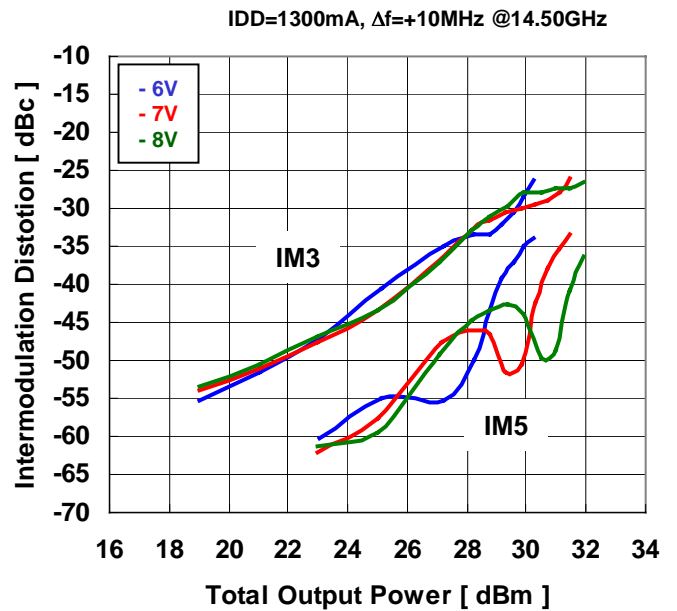
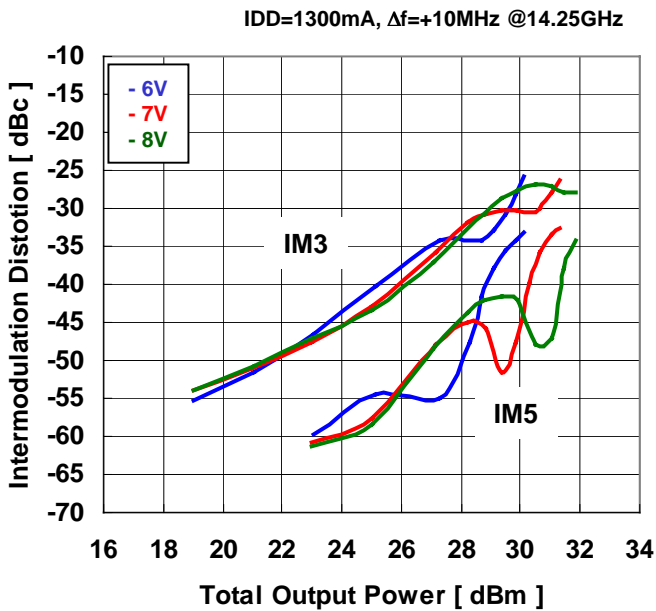
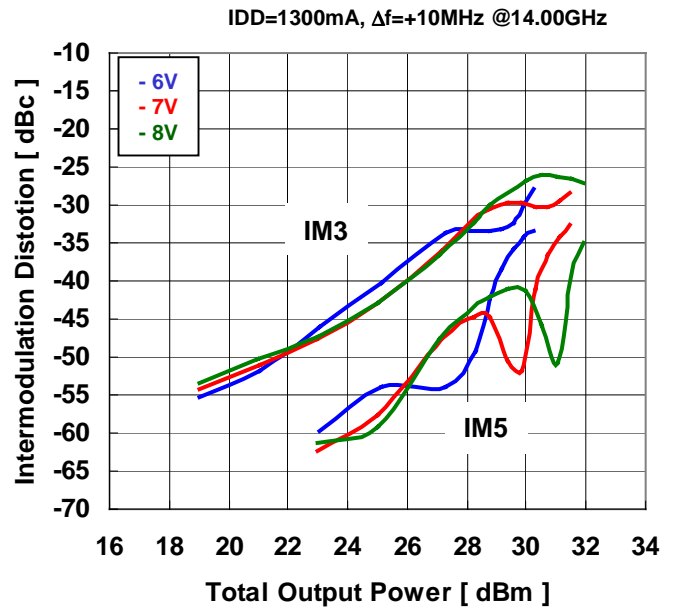
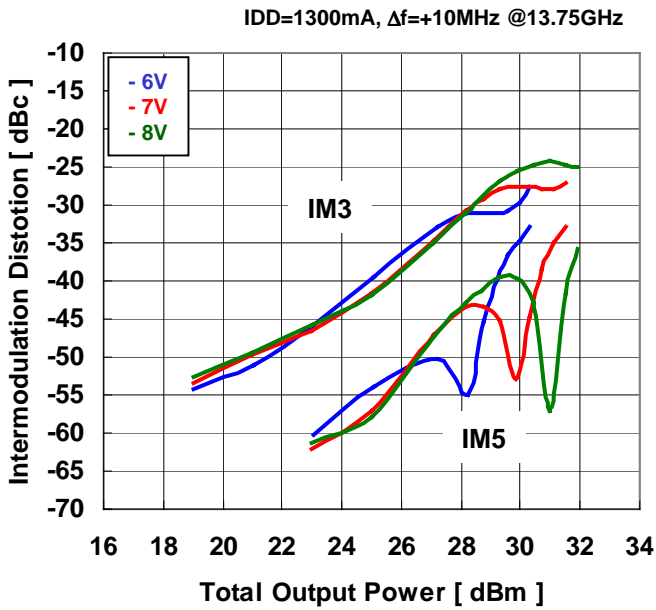

# FMM5059VF

## Ku band Power Amplifier MMIC

OUTPUT POWER, DRAIN CURRENT vs. INPUT POWER by Drain Current

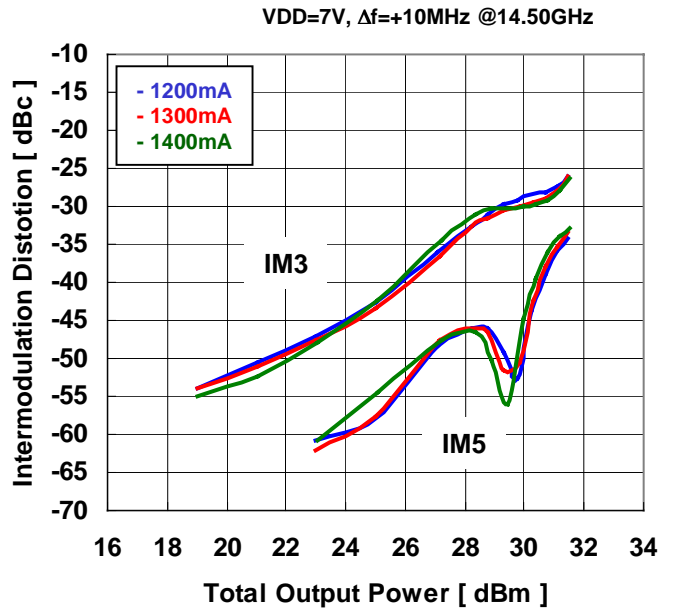
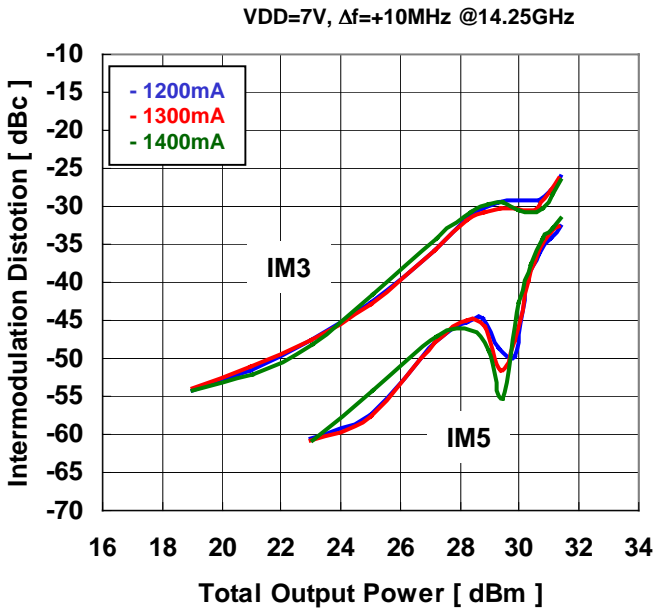
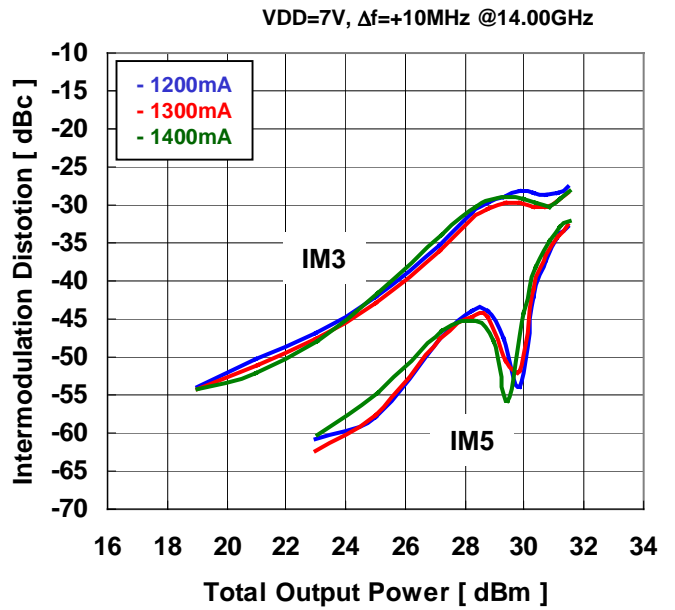
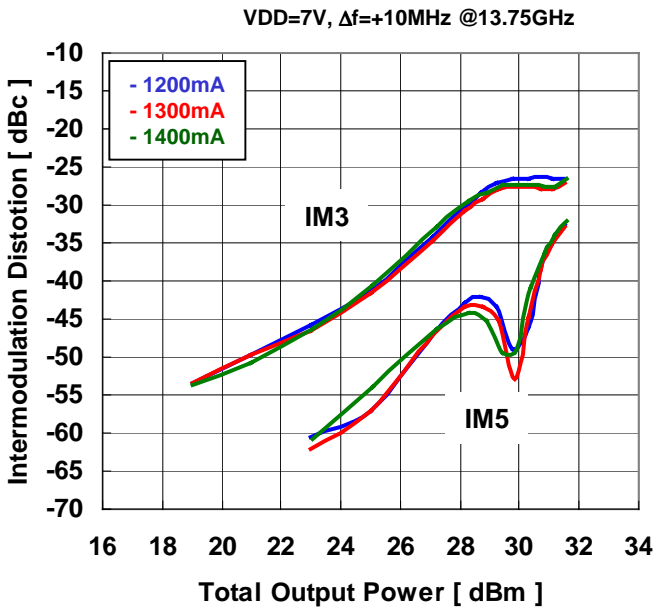

# FMM5059VF

## Ku Band Power Amplifier MMIC

OUTPUT POWER , DRAIN CURRENT vs. INPUT POWER by temperature

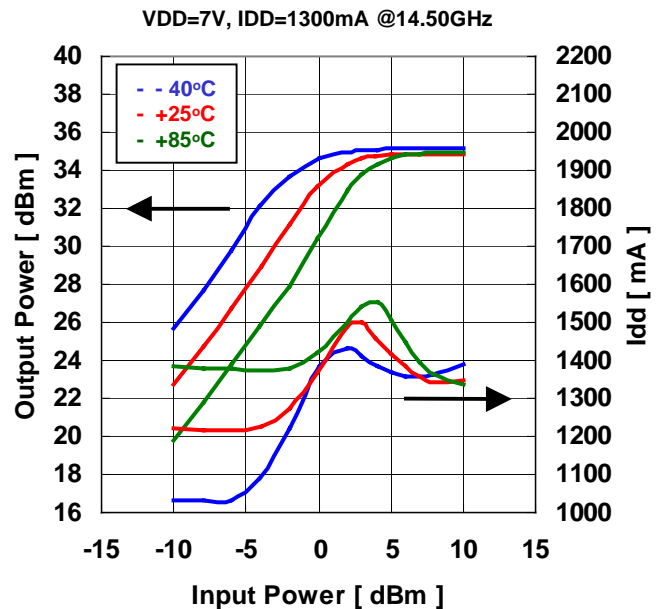
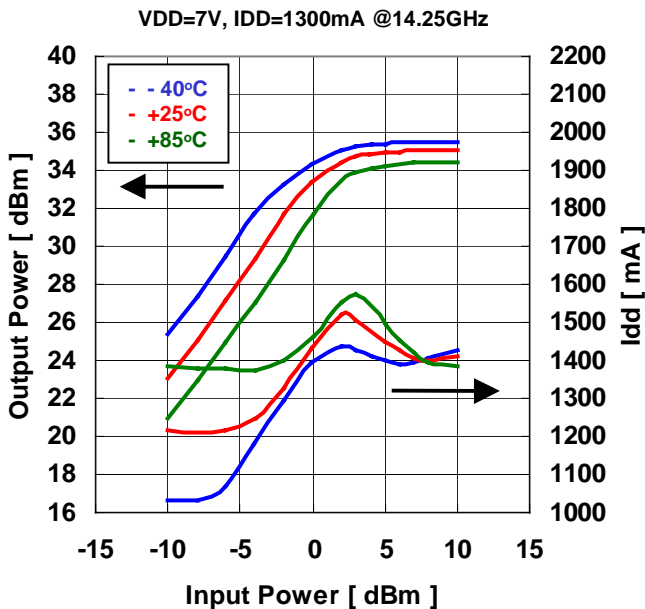
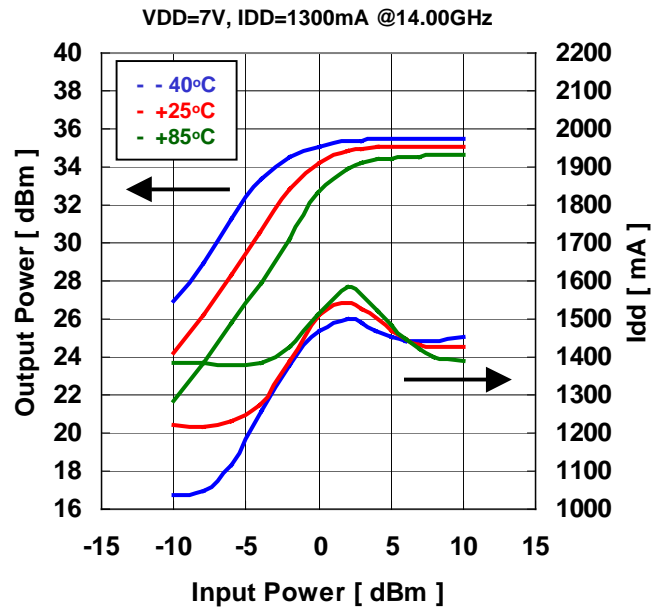
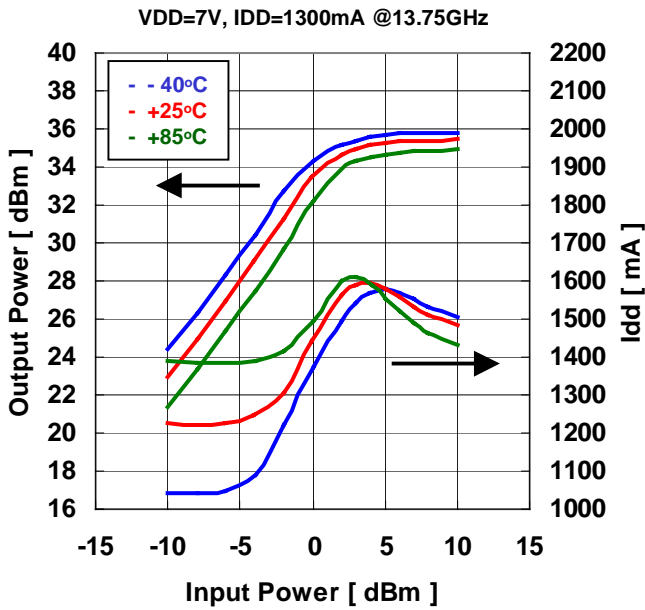

# FMM5059VF

## Ku band Power Amplifier MMIC

### IMD PERFORMANCE vs. OUTPUT POWER by temperature

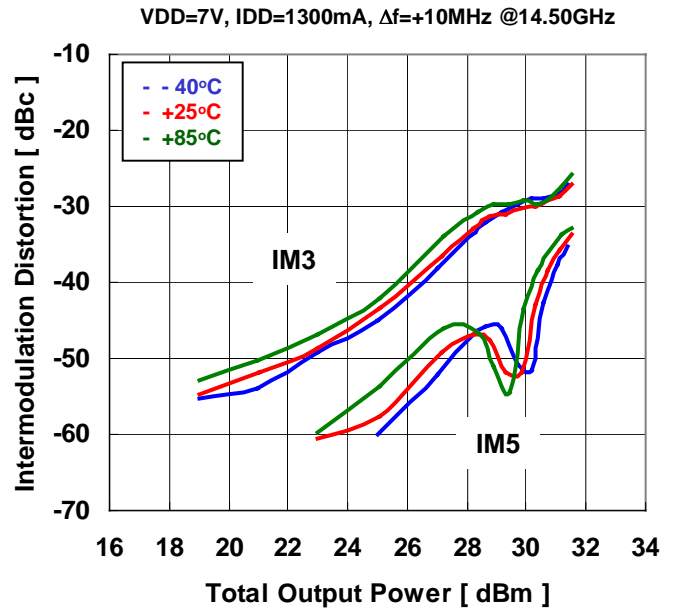
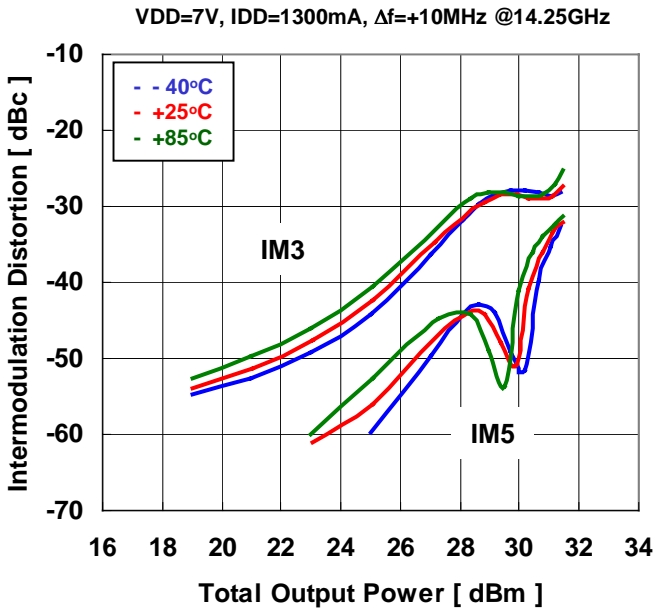
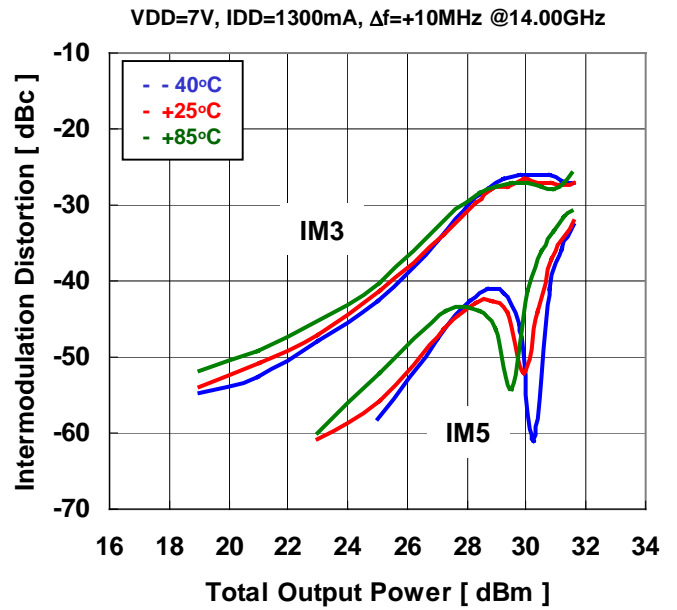
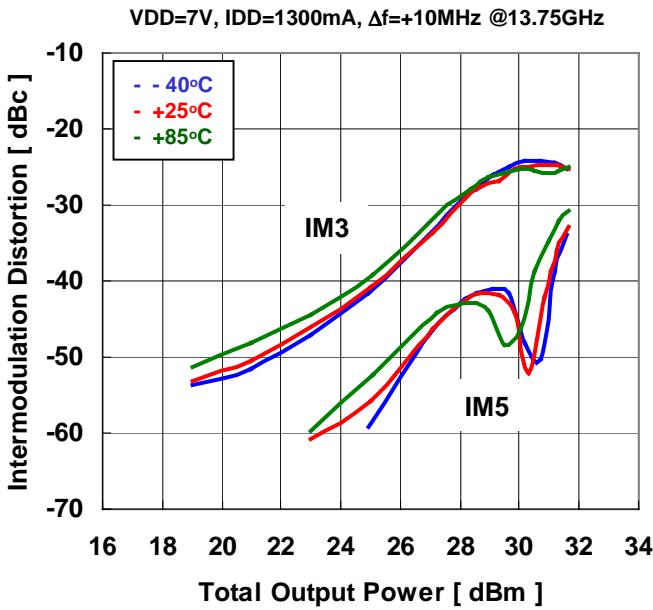



# FMM5059VF

## Ku Band Power Amplifier MMIC

P1dB, G1dB vs. TEMPERATURE

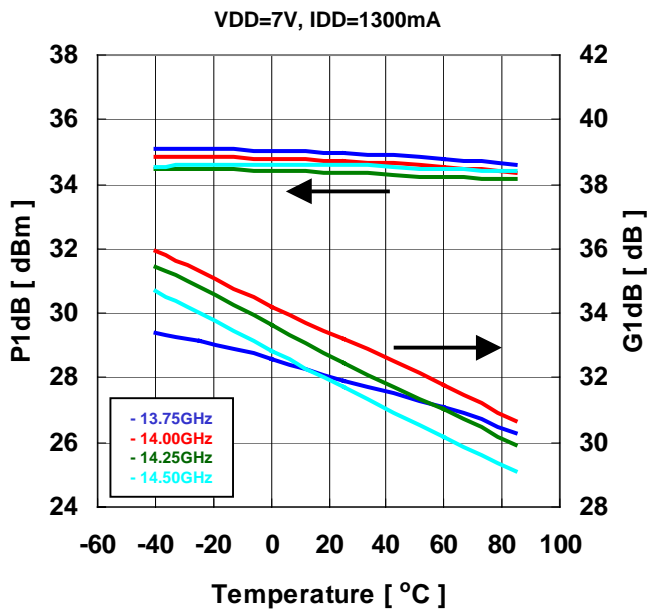

IMD PERFORMANCE vs. TEMPERATURE

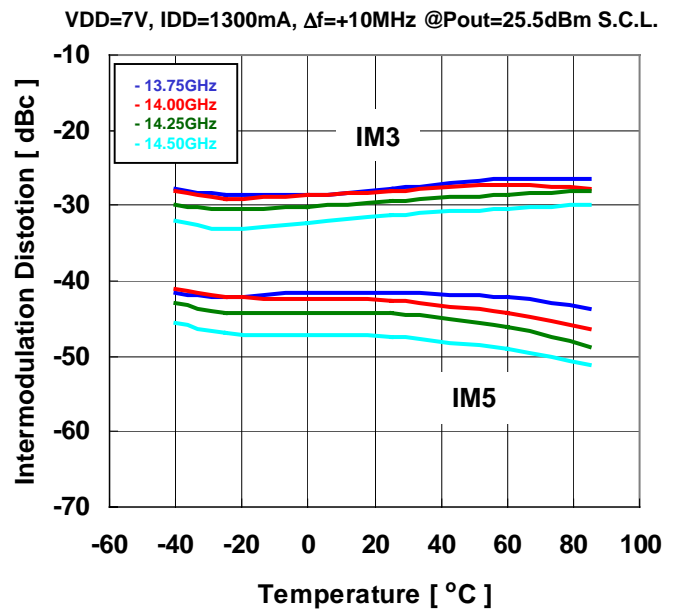

P1dB, G1dB vs. DRAIN VOLTAGE

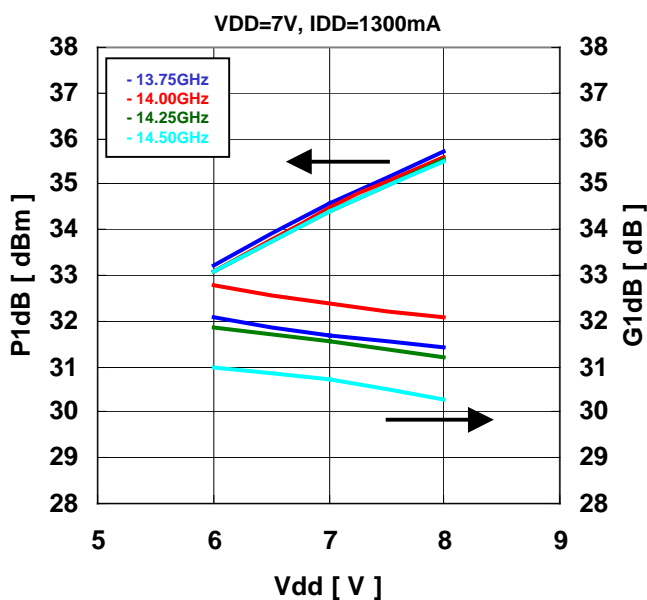

IMD PERFORMANCE vs. DRAIN VOLTAGE

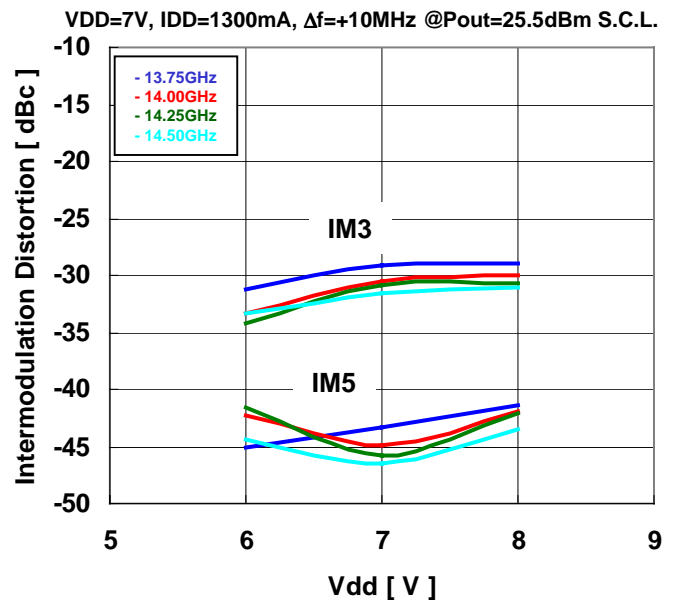

# FMM5059VF

Ku band Power Amplifier MMIC

## ■ S-PARAMETER

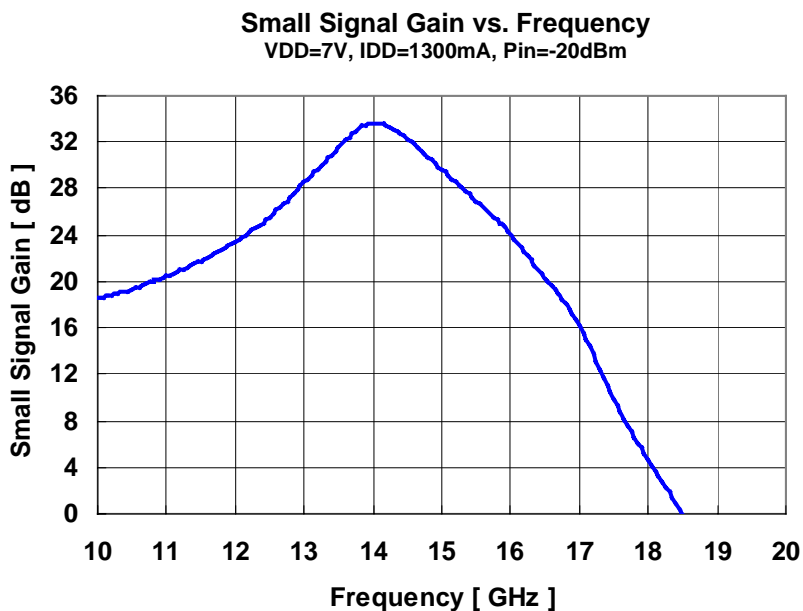
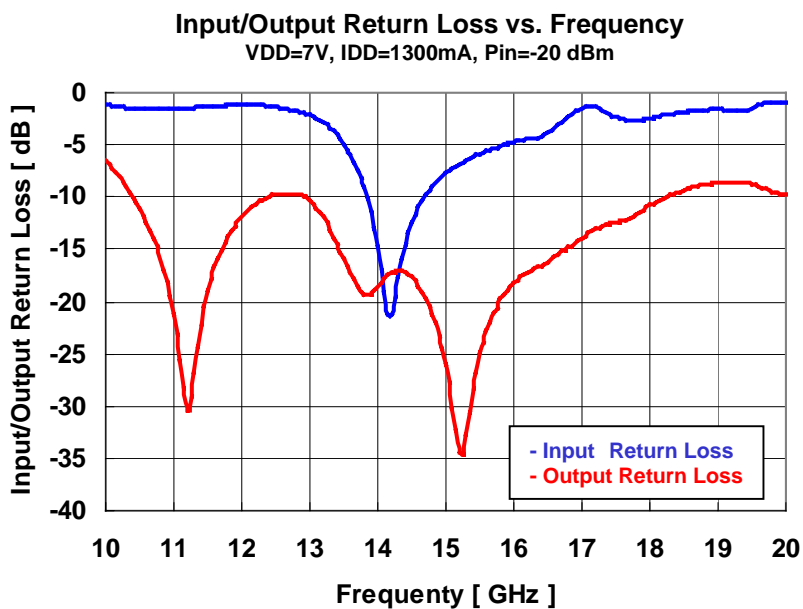

# FMM5059VF

## Ku Band Power Amplifier MMIC

### ■ S-PARAMETER

Vdd=7.0V , Idd=1300mA

Frequency [ GHz ]	S11		S21		S12		S22	
	MAG	ANG	MAG	ANG	MAG	ANG	MAG	ANG
1.00	0.982	-36.6	0.042	30.9	0.000	146.3	0.984	-44.5
2.00	0.953	-72.0	0.065	138.5	0.000	-172.8	0.928	-85.0
3.00	0.959	-103.2	0.035	61.9	0.001	168.3	0.922	-121.3
4.00	0.961	-134.0	0.009	105.6	0.001	142.4	0.941	-160.0
5.00	0.937	-170.6	0.037	95.6	0.003	102.7	0.907	154.2
6.00	0.929	149.5	0.105	67.6	0.002	51.0	0.865	104.8
7.00	0.922	114.1	0.580	32.6	0.001	-6.4	0.848	54.8
8.00	0.912	82.4	3.917	-91.8	0.001	-68.7	0.786	4.6
9.00	0.901	47.7	6.752	134.7	0.002	-112.5	0.682	-47.2
10.00	0.873	12.5	8.466	20.7	0.005	-172.0	0.468	-108.9
11.00	0.841	-16.8	10.539	-78.4	0.003	169.2	0.087	178.1
12.00	0.871	-49.0	14.729	-175.5	0.005	132.1	0.254	-30.0
13.00	0.778	-91.8	26.724	79.0	0.004	77.8	0.303	-88.6
13.25	0.699	-107.9	31.697	47.4	0.003	59.8	0.238	-101.9
13.50	0.565	-125.6	37.651	12.9	0.002	57.7	0.160	-104.4
13.55	0.531	-129.8	38.949	5.7	0.001	59.4	0.149	-103.3
13.60	0.500	-134.1	40.388	-1.7	0.001	66.8	0.137	-101.8
13.65	0.466	-138.8	41.719	-9.5	0.001	69.9	0.128	-99.7
13.70	0.426	-144.2	43.073	-17.3	0.001	76.1	0.119	-96.3
13.75	0.388	-149.7	44.407	-26.0	0.001	83.2	0.111	-92.6
13.80	0.351	-155.8	45.614	-34.5	0.001	92.8	0.109	-86.8
13.85	0.309	-162.4	46.435	-43.1	0.001	93.9	0.107	-82.4
13.90	0.266	-170.5	47.323	-51.7	0.001	97.0	0.109	-77.9
13.95	0.224	-178.8	47.744	-60.7	0.002	98.8	0.112	-73.9
14.00	0.182	171.4	47.876	-69.5	0.002	100.4	0.118	-70.9
14.05	0.142	157.7	48.039	-78.4	0.002	102.0	0.123	-70.1
14.10	0.111	138.8	47.799	-87.2	0.002	100.5	0.129	-70.7
14.15	0.087	110.5	47.734	-96.0	0.002	99.4	0.134	-71.7
14.20	0.087	77.2	47.097	-104.8	0.002	99.4	0.137	-73.2
14.25	0.105	51.7	46.356	-113.6	0.002	97.4	0.138	-75.3
14.30	0.132	34.4	45.410	-122.0	0.002	94.2	0.141	-77.5
14.35	0.160	22.1	44.288	-130.6	0.002	93.3	0.140	-80.2
14.40	0.187	13.1	43.248	-138.6	0.003	91.4	0.138	-83.3
14.45	0.212	5.8	42.185	-146.7	0.003	88.9	0.135	-86.4
14.50	0.238	-0.2	40.951	-154.6	0.003	87.1	0.130	-89.1
14.75	0.340	-23.5	35.392	167.6	0.003	77.6	0.095	-106.0
15.00	0.412	-39.9	30.342	132.3	0.003	67.7	0.049	-129.7
16.00	0.579	-98.0	15.931	-5.1	0.006	38.3	0.123	24.9
17.00	0.843	-151.0	6.425	-139.1	0.022	-41.8	0.199	-88.7
18.00	0.751	171.8	1.709	115.9	0.009	-157.0	0.289	155.2
19.00	0.832	153.1	0.604	27.5	0.004	150.9	0.371	114.4
20.00	0.902	137.2	0.288	-62.7	0.006	141.9	0.324	53.7

# FMM5059VF

Ku band Power Amplifier MMIC

$\Delta T_{ch}$  vs. DRAIN VOLTAGE  
(Reference Data)

$I_{DD}=1300mA$

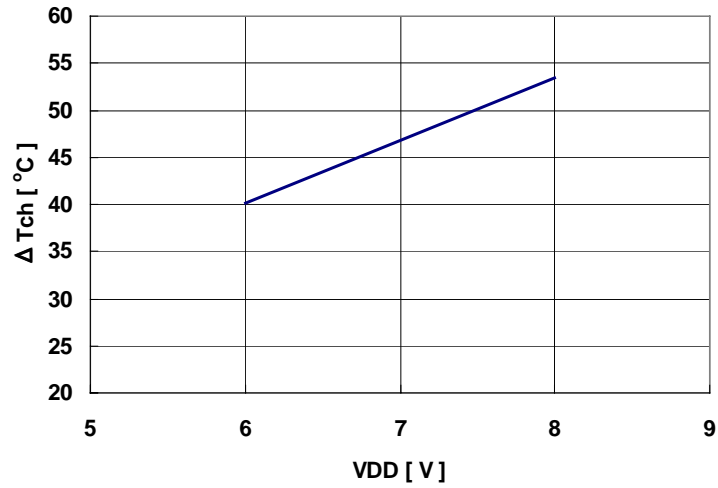

Note :  $\Delta T_{ch}$  : Case to Channel Temperature Rise

MTTF vs.  $T_{ch}$

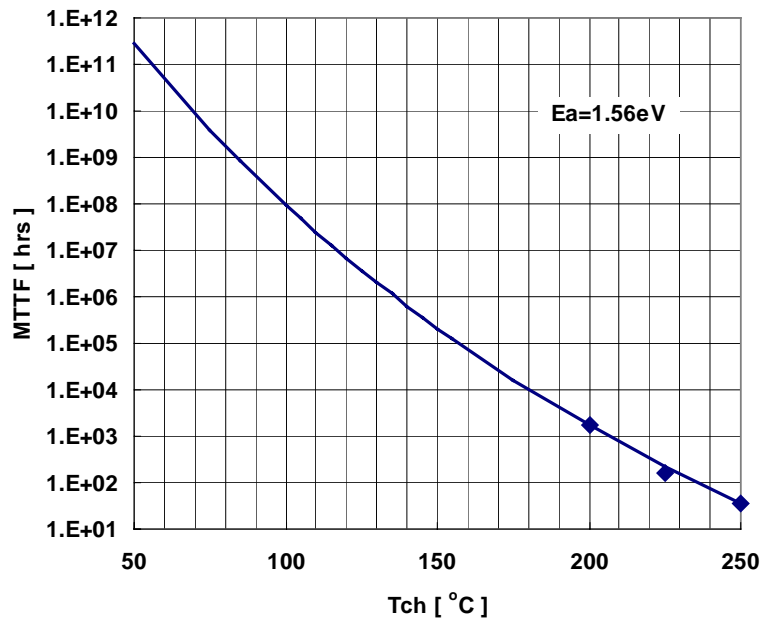

# FMM5059VF

## Ku Band Power Amplifier MMIC

### Package Out Line

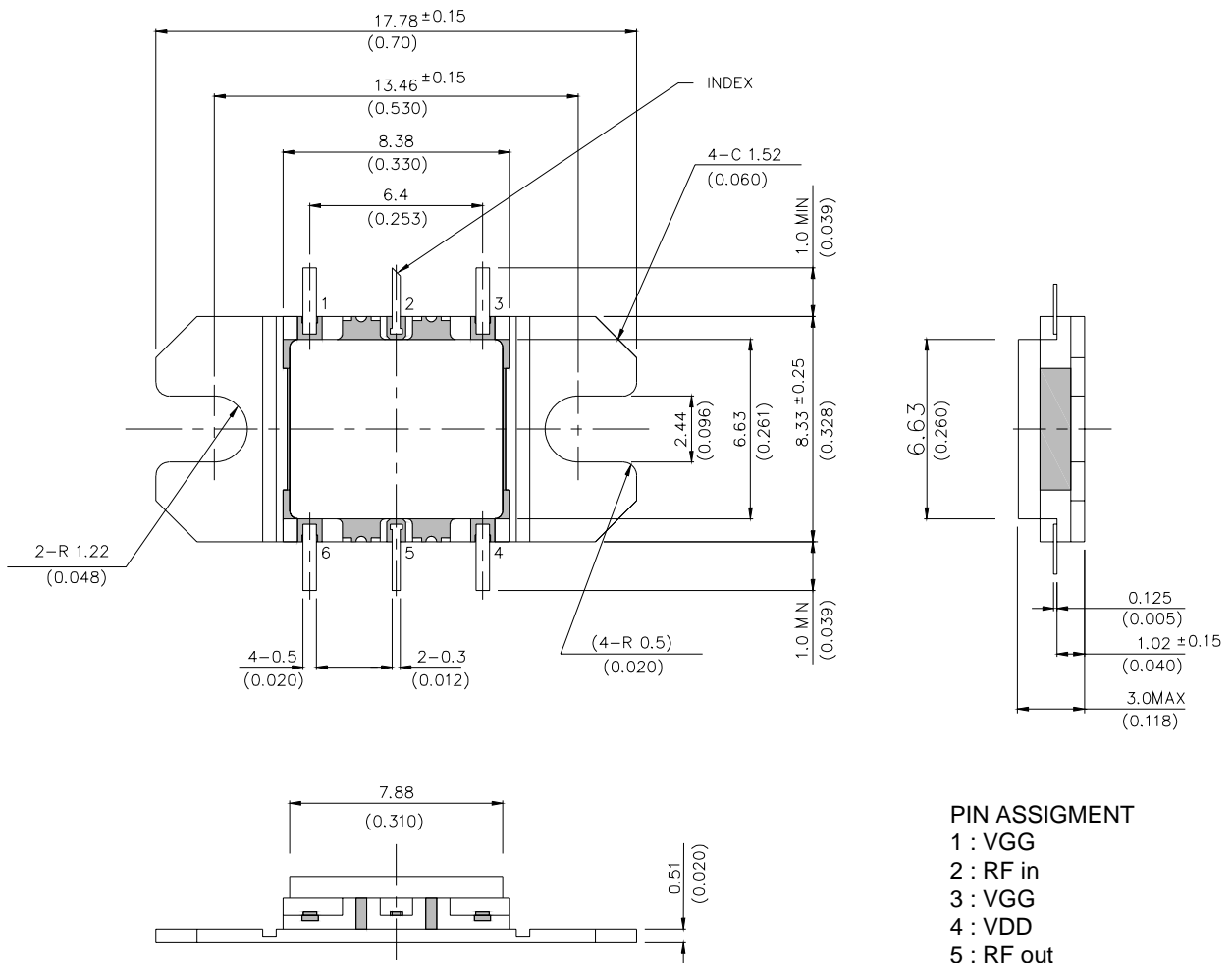

### PIN ASSIGNMENT

- 1 : VGG
- 2 : RF in
- 3 : VGG
- 4 : VDD
- 5 : RF out
- 6 : VDD

---

# FMM5059VF

## Ku band Power Amplifier MMIC

---

### ■ Mounting Instructions for VF Package

#### 1. Screw Mounting

- (1) The flange of package may be attached using screws. Torque conditions are shown in table 1.

Table 1. Recommended and Maximum Torque for Screw Mounting

Package	Recommended screw	Recommended Torque	Maximum Torque
VF	M2.0	10 N-cm (0.9 lb-in)	15 N-cm (1.3 lb-in)

- (2) First, tighten the screws with a torque driver set to 5 N-cm.
- (3) The surface finish of the heat sink should be better than 0.8  $\mu\text{m}$ , and the surface flatness must be better than 10  $\mu\text{m}$ .
- (4) Silicon based heat sink compounds should not be used for the thermal conductive grease. They cause poor grounding of the source flange, contamination and long term degradation of thermal resistance between the FET package and heat sink.

#### 2. Solder Mounting

- (1) Recommended solder are Tin-Lead solder (63Sn/37Pb), Lead-Free solder (Sn-3.0Ag-0.5Cu)\*<sup>1</sup> or equivalent.
- (2) For soldering, Tin-Lead solder (63Sn/37Pb) or Lead-Free solder (Sn-3.0Ag-0.5Cu)\*<sup>1</sup> shall be used. (\*1: The figure displays with weight %. A predominantly tin-rich alloy with 3.0% silver and 0.5% copper.)
- (3) Recommended Flux is Rosin type with chlorine content: 0.2% or less and a low halogen content. After soldering, the flux residue should be removed by appropriate cleaning methods.
- (4) The recommended soldering conditions are as follows:

Partial heating method (soldering iron, spot laser/air)

Product terminal temperature: 260 deg-C, max. 10 s./terminal or

400 deg-C, max. 3 s./terminal

---

---

---

# FMM5059VF

## Ku Band Power Amplifier MMIC

### ■ Recommended Bias Circuit and Internal Block Diagram

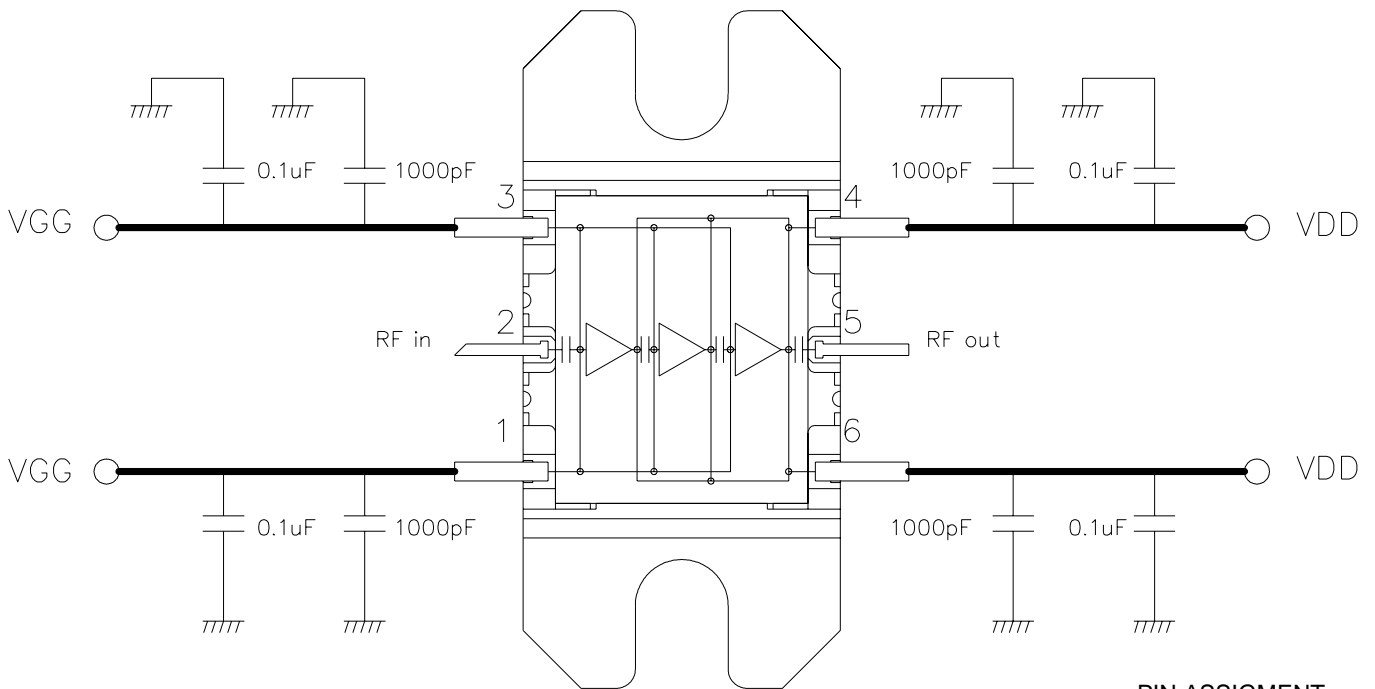

**PIN ASSIGNMENT**  
1 : VGG  
2 : RF in  
3 : VGG  
4 : VDD  
5 : RF out  
6 : VDD

Note 1: The capacitors are recommended on the bias supply line, close to the package, in order to prevent video oscillations which could damage the module.

Note 2: Two pins both VGG and VDD are internally connected respectively.

# **FMM5059VF**

## **Ku band Power Amplifier MMIC**

### **EUDYNA DEVICES USA INC.**

2355 Zanker Road  
San Jose, CA 95131  
Phone: +408-232-9500  
FAX: +408-428-9111

### **EUDYNA DEVICES EUROPE LTD.**

Norreys Drive  
Maidenhead Berkshire, SL6 4FJ United Kingdom  
Phone: +44-1628-504800  
FAX: +44-1628-504888

### **EUDYNA DEVICES ASIA PTE. LTD. HONG KONG BRANCH**

Rm. 1101, Ocean Centre, 5 Canton Road, Tsim Sha Tsui, Kowloon,  
Honk Kong  
Tel: +852-2377-0227  
Fax: +852-2377-3921

### **EUDYNA DEVICES INC.**

#### **JAPANESE SALES OFFICE(Head Office)**

1, Kanai-cho, Sakae-ku, Yokohama,  
244-0845, Japan  
Tel: +81-45-853-8150  
Fax: +81-45-853-8170  
[www.eudyna.com](http://www.eudyna.com)

#### **CAUTION**

Eudyna Devices Compound Semiconductor Products contain **gallium arsenide (GaAs)** which can be hazardous to the human body and the environment.

For safety, observe the following procedures:

- Do not put these products into the mouth.
- Do not alter the form of this product into a gas, powder, or liquid through burning, crushing, or chemical processing as these by-products are dangerous to the human body if inhaled, ingested, or swallowed.
- Observe government laws and company regulations when discarding this product. This product must be discarded in accordance with methods specified by applicable hazardous waste procedures.

Eudyna Devices Incorporated reserves the right to change products and specifications without notice.  
The information does not convey any license under rights of Eudyna Devices Incorporated or others.

**Eudyna**