

## Gallium Nitride 28V, 200W RF Power Transistor

Built using the SIGANTIC® NRF1 process - A proprietary GaN-on-Silicon technology

### FEATURES

- Optimized for narrowband and broadband applications from DC – 1200MHz
- 200W P<sub>3dB</sub> CW power at 900MHz in quadrature combined or push-pull configuration
- 90W CW power from 500-1000MHz in application design [AD-014](#)
- High efficiency from 14V to 28V
- 1.0 °C/W R<sub>TH</sub> with maximum T<sub>J</sub> rating of 200°C
- Robust up to 10:1 VSWR mismatch at all angles with no device degradation
- Subject to EAR99 export control

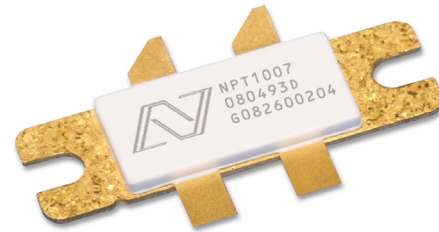

**DC – 1200 MHz**  
**14 – 28 Volt**  
**GaN HEMT**



**RF Specifications (CW):** V<sub>DS</sub> = 28V, I<sub>DQ</sub> = 1400mA<sup>1</sup>, Frequency = 900MHz, T<sub>A</sub> = 25°C, Measured in Nitronex Quadrature Combined Test Fixture<sup>2</sup>.

Symbol	Parameter	Min	Typ	Max	Units
P <sub>3dB</sub>	Average Output Power at 3dB Gain Compression	52.0	53.0	-	dBm
G <sub>SS</sub>	Small Signal Gain	17.3	18.3	-	dB
η	Drain Efficiency at 3dB Gain Compression <sup>2</sup>	57	63	-	%
VSWR	10:1 VSWR at all phase angles	No change in device performance			

Note 1: 700mA per transistor. Each gate should be biased independently to set desired I<sub>DQ</sub>.

Note 2: Includes ~ 0.2 dB quadrature combiner loss.

**Typical 2-Tone Performance:** V<sub>DS</sub> = 28V, I<sub>DQ</sub> = 1400mA<sup>1</sup>, Frequency = 900MHz, Tone spacing = 1MHz, T<sub>A</sub> = 25°C Measured in Nitronex Quadrature Combined Test Fixture<sup>2</sup>.

Symbol	Parameter	Typ	Units
P <sub>3dB,PEP</sub>	Peak Envelope Power at 3dB Gain Compression	53.4	dBm
P <sub>1dB,PEP</sub>	Peak Envelope Power at 1dB Gain Compression	52.6	dBm
P <sub>IMD3</sub>	Peak Envelope Power at -35dBc IMD3	50.8	dBm

Note 1: 700mA per transistor. Each gate should be biased independently to set desired I<sub>DQ</sub>.

Note 2: Includes ~ 0.2 dB quadrature combiner loss.

# NPT1007 Datasheet



## DC Specifications: Per Transistor, $T_A = 25^\circ\text{C}$

Symbol	Parameter	Min	Typ	Max	Units
<b>Off Characteristics</b>					
$V_{BDS}$	Drain-Source Breakdown Voltage ( $V_{GS} = -8\text{V}$ , $I_D = 36\text{mA}$ )	100	-	-	V
$I_{DLK}$	Drain-Source Leakage Current ( $V_{GS} = -8\text{V}$ , $V_{DS} = 60\text{V}$ )	-	9	18	mA
<b>On Characteristics</b>					
$V_T$	Gate Threshold Voltage ( $V_{DS} = 28\text{V}$ , $I_D = 36\text{mA}$ )	-2.3	-1.8	-1.3	V
$V_{GSQ}$	Gate Quiescent Voltage ( $V_{DS} = 28\text{V}$ , $I_D = 700\text{mA}$ )	-2.0	-1.5	-1.0	V
$R_{ON}$	On Resistance ( $V_{GS} = 2\text{V}$ , $I_D = 270\text{mA}$ )	-	0.13	0.14	$\Omega$
$I_{D,MAX}$	Drain Current ( $V_{DS} = 7\text{V}$ pulsed, 300 $\mu\text{s}$ pulse width, 0.2% duty cycle)	19.0	20.5	-	A

## Absolute Maximum Ratings: Not Simultaneous, Per Transistor, $T_A = 25^\circ\text{C}$ Unless Otherwise Noted

Symbol	Parameter	Max	Units
$V_{DS}$	Drain-Source Voltage	100	V
$V_{GS}$	Gate-Source Voltage	-10 to 3	V
$I_G$	Gate Current	180	mA
$P_T$	Total Device Power Dissipation (Derated above $25^\circ\text{C}$ ), both transistors on	175	W
$\theta_{JC}$	Thermal Resistance (Junction-to-Case), composite for both transistors on, $T_J = 180^\circ\text{C}$	1.0	$^\circ\text{C}/\text{W}$
	Thermal Resistance (Junction-to-Case), one transistor on, one off, $T_J = 180^\circ\text{C}$	1.8	
$T_{STG}$	Storage Temperature Range	-65 to 150	$^\circ\text{C}$
$T_J$	Operating Junction Temperature	200	$^\circ\text{C}$
HBM	Human Body Model ESD Rating (per JESD22-A114)	1C (>1000V)	
MM	Machine Model ESD Rating (per JESD22-A115)	A (>100V)	
CDM	Charge Device Model ESD Rating (per JESD22-C101)	IV (>4000V)	

## Load-Pull Data, Reference Plane at Device Leads

$V_{DS}=28V$ ,  $I_{DQ}=700mA$ , One Single-Ended Transistor,  $T_A=25^\circ C$  Unless Otherwise Noted

**Table 1:** Optimum Source and Load Impedances for CW Gain, Drain Efficiency, and Output Power Performance

Frequency (MHz)	$Z_S (\Omega)$	$Z_L (\Omega)$	$P_{SAT}$ (dBm)	$G_{SS}$ (dB)	Drain Efficiency @ $P_{SAT}$ (%)
500	$1.4 + j0.1$	$2.0 + j0.5$	50.0	24.0	70%
900	$1.6 - j1.5$	$2.3 - j1.5$	50.0	18.5	74%
1200	$1.8 - j2.7$	$3.5 - j2.8$	49.5	16.5	62%

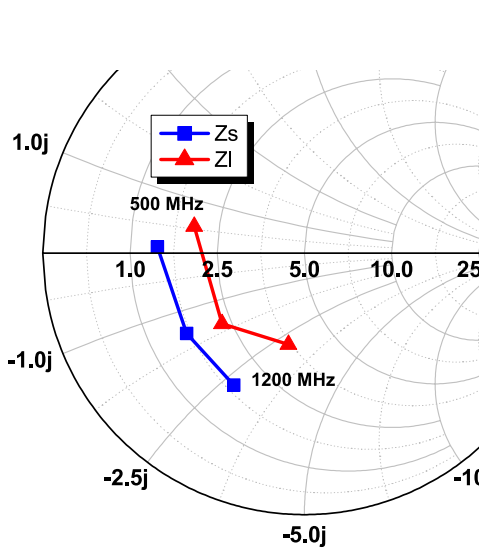
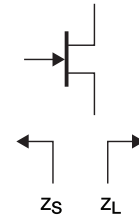

**Figure 1 -** Optimum Impedances for CW Performance

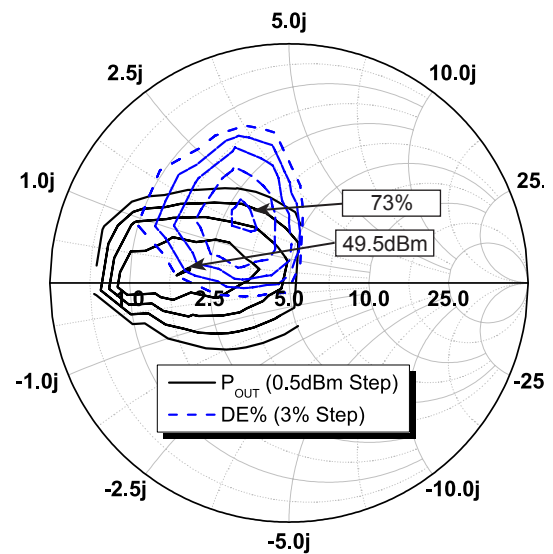

**Figure 2 -** Load-Pull Contours, 500MHz,  $P_{IN} = 25dBm$ ,  $Z_S = 1.4 + j0.1 \Omega$

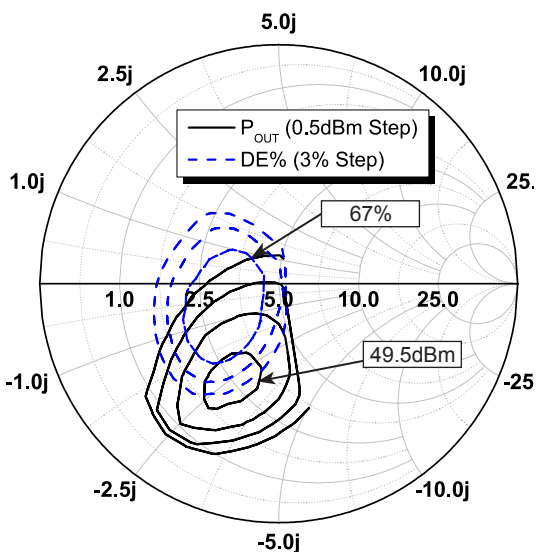

**Figure 3 -** Load-Pull Contours, 900MHz,  $P_{IN} = 30dBm$ ,  $Z_S = 1.6 - j1.5 \Omega$

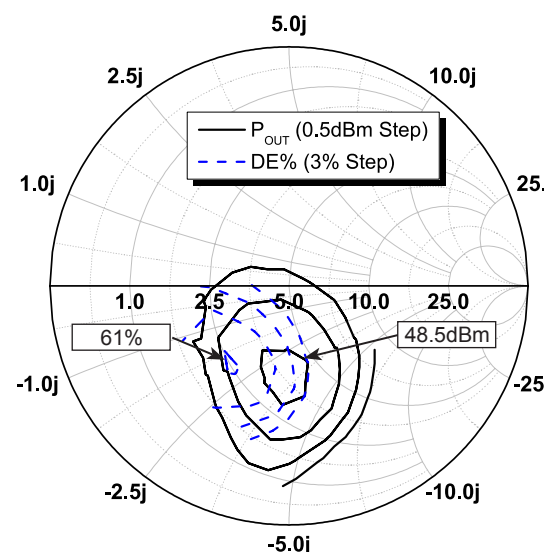

**Figure 4 -** Load-Pull Contours, 1200MHz,  $P_{IN} = 32dBm$ ,  $Z_S = 1.8 - j2.7 \Omega$

## Load-Pull Data, Reference Plane at Device Leads

$V_{DS}=28V$ ,  $I_{DQ}=700mA$ , One Single-Ended Transistor,  $T_A=25^\circ C$  unless otherwise noted.

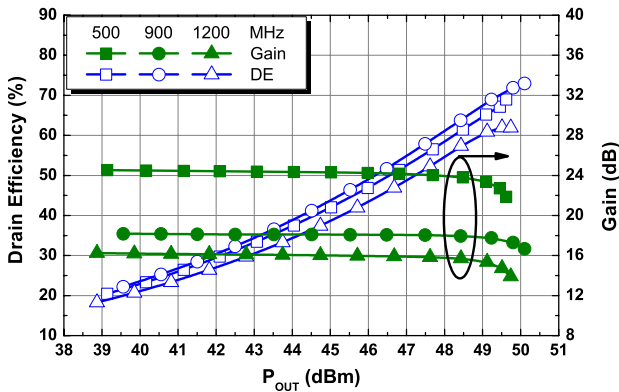

**Figure 5** - Typical CW Performance, over Frequency

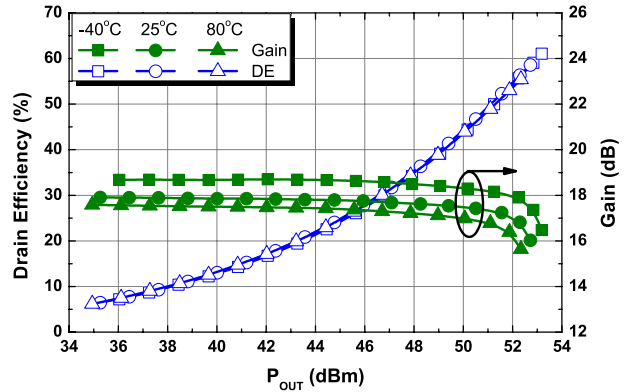

**Figure 6** - Typical CW Performance over Temperature in Nitronex Quadrature Combined Test Fixture, Frequency = 900MHz

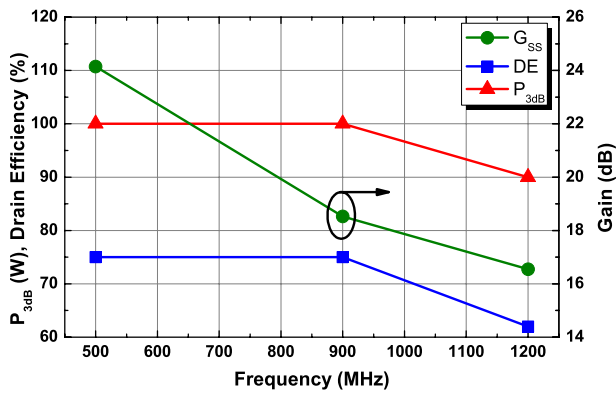

**Figure 7** - Typical CW Performance over Frequency

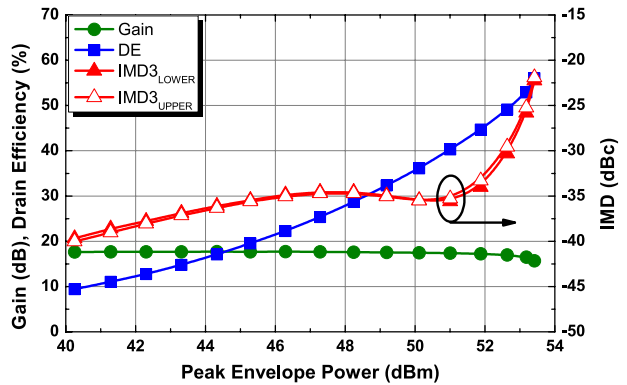

**Figure 8** - Typical IMD3 Performance, in Nitronex Quadrature Combined Test Fixture Frequency = 900MHz, Tone spacing = 1MHz

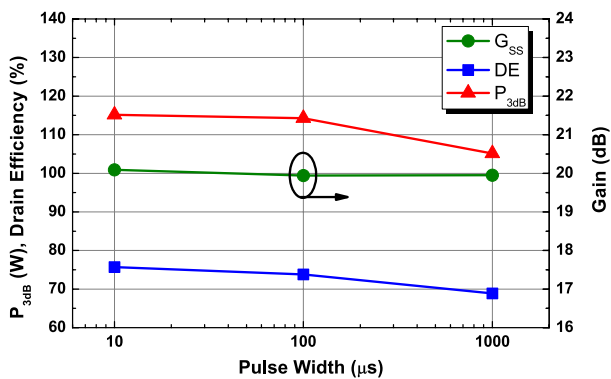

**Figure 9** - Typical Pulsed Performance, Frequency = 900MHz, Duty Cycle = 10%

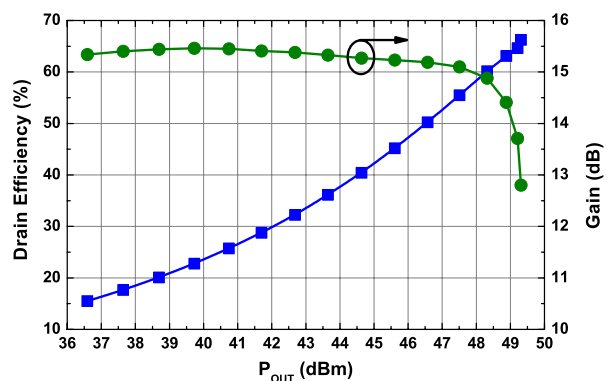

**Figure 10** - Typical CW Performance at  $V_{DS} = 20V$  Frequency = 900MHz

## Typical Device Characteristics

$V_{DS}=28V$ ,  $I_{DQ}=700mA$ , One Single-Ended Transistor,  $T_A=25^\circ C$  unless otherwise noted.

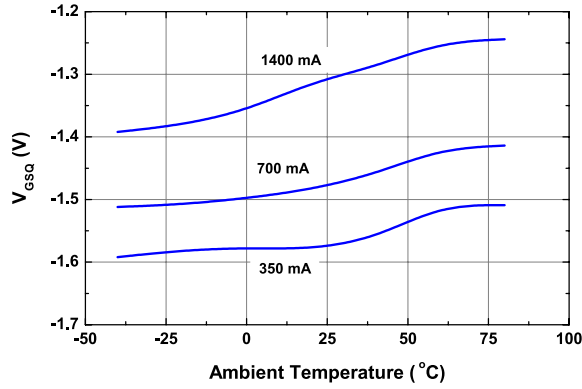

**Figure 11** - Quiescent Gate Voltage ( $V_{GSQ}$ ) Required to Reach  $I_{DQ}$  over Temperature

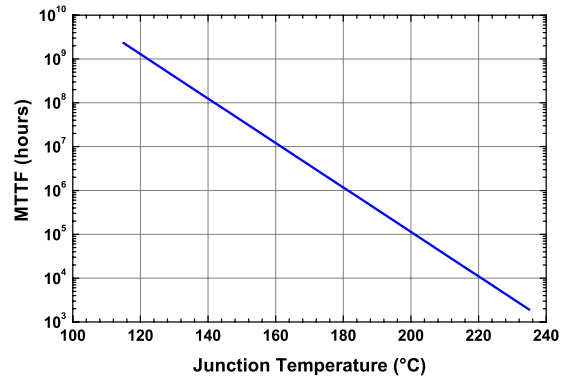

**Figure 12** - MTTF of NRF1 Devices

# NPT1007 Datasheet

## Ordering Information<sup>1</sup>

Part Number	Description
NPT1007B	NPT1007 in AC780BM-F4 Bolt-Down Package

1: To find a Nitronex contact in your area, visit our website at <http://www.nitronex.com>

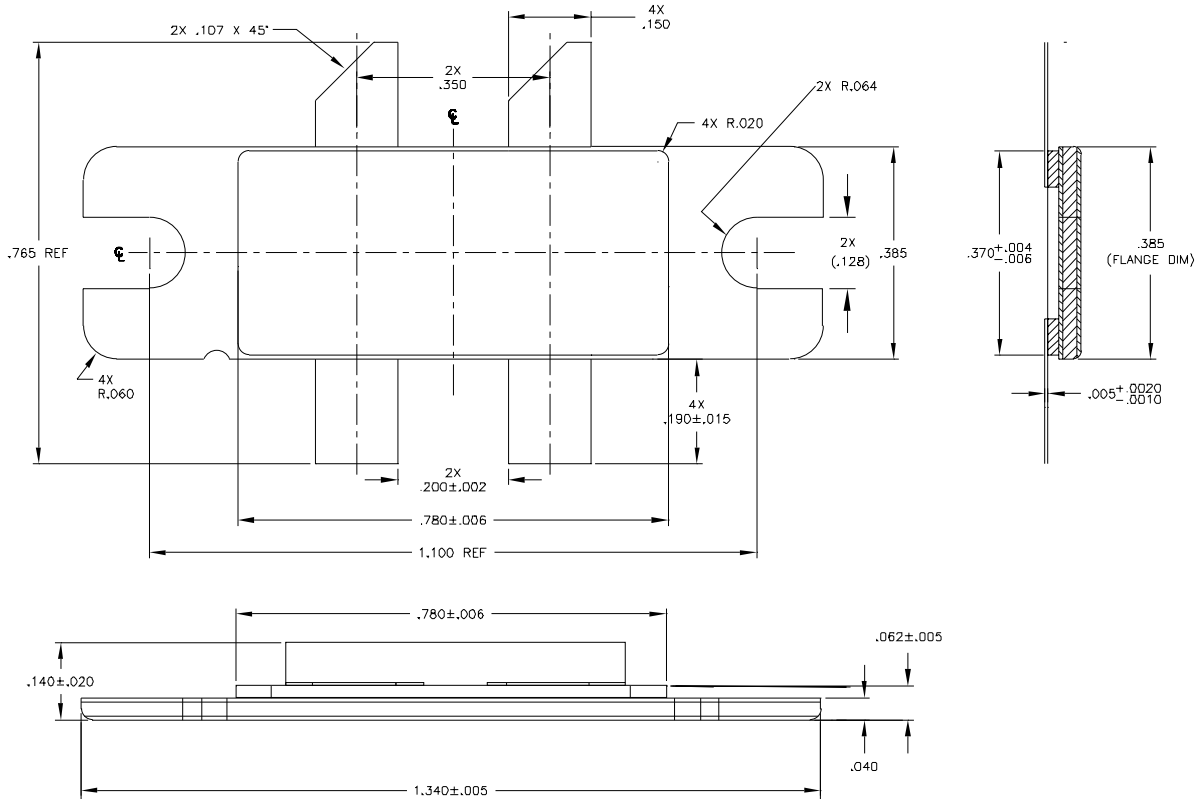

**Figure 13 - AC780BM-F4 Package Dimensions and Pinout (all dimensions are in inches)**

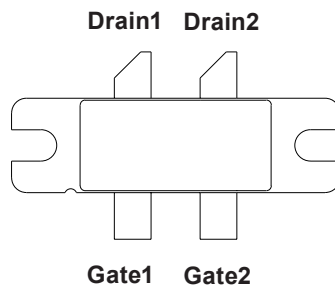

**Figure 14 - Terminal Identification**

## Nitronex Corporation

2305 Presidential Drive  
Durham, NC 27703 USA  
+1.919.807.9100 (telephone)  
+1.919.807.9200 (fax)  
info@nitronex.com  
www.nitronex.com

## Additional Information

**This part is lead-free and is compliant with the RoHS directive  
(Restrictions on the Use of Certain Hazardous Substances in Electrical and Electronic Equipment).**

## Important Notice

Nitronex Corporation reserves the right to make corrections, modifications, enhancements, improvements and other changes to its products and services at any time and to discontinue any product or service without notice. Customers should obtain the latest relevant information before placing orders and should verify that such information is current and complete. All products are sold subject to Nitronex terms and conditions of sale supplied at the time of order acknowledgment. The latest information from Nitronex can be found either by calling Nitronex at 1-919-807-9100 or visiting our website at [www.nitronex.com](http://www.nitronex.com).

Nitronex warrants performance of its packaged semiconductor or die to the specifications applicable at the time of sale in accordance with Nitronex standard warranty. Testing and other quality control techniques are used to the extent Nitronex deems necessary to support the warranty. Except where mandated by government requirements, testing of all parameters of each product is not necessarily performed.

Nitronex assumes no liability for applications assistance or customer product design. Customers are responsible for their product and applications using Nitronex semiconductor products or services. To minimize the risks associated with customer products and applications, customers should provide adequate design and operating safeguards.

Nitronex does not warrant or represent that any license, either express or implied, is granted under any Nitronex patent right, copyright, mask work right, or other Nitronex intellectual property right relating to any combination, machine or process in which Nitronex products or services are used.

Reproduction of information in Nitronex data sheets is permitted if and only if said reproduction does not alter any of the information and is accompanied by all associated warranties, conditions, limitations and notices. Any alteration of the contained information invalidates all warranties and Nitronex is not responsible or liable for any such statements.

Nitronex products are not intended or authorized for use in life support systems, including but not limited to surgical implants into the body or any other application intended to support or sustain life. Should Buyer purchase or use Nitronex Corporation products for any such unintended or unauthorized application, Buyer shall indemnify and hold Nitronex Corporation, its officers, employees, subsidiaries, affiliates, distributors, and its successors harmless against all claims, costs, damages, and expenses, and reasonable attorney fees arising out of, directly or indirectly, any claim of personal injury or death associated with such unintended or unauthorized use, notwithstanding if such claim alleges that Nitronex was negligent regarding the design or manufacture of said products.

Nitronex and the Nitronex logo are registered trademarks of Nitronex Corporation.  
All other product or service names are the property of their respective owners.  
©Nitronex Corporation 2007. All rights reserved.