

The RF MOSFET Line
RF Power Field Effect Transistor
N-Channel Enhancement-Mode Lateral MOSFET

MRF6522-70R3

Designed for GSM 900 frequency band, the high gain and broadband performance of this device make it ideal for large-signal, common source amplifier applications in 26 volt base station equipment.

- Specified Performance @ Full GSM Band, 921-960 MHz, 26 Volts
 Output Power, P1dB — 80 Watts (Typ)
 Power Gain @ P1dB — 16 dB (Typ)
 Efficiency @ P1dB — 58% (Typ)
- Available in Tape and Reel. R3 Suffix = 250 Units per 32 mm, 13 inch Reel.

921 - 960 MHz, 70 W, 26 V
LATERAL N-CHANNEL
RF POWER MOSFET

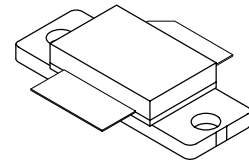

CASE 465D-05, STYLE 1
NI-600

MAXIMUM RATINGS

Rating	Symbol	Value	Unit
Drain-Source Voltage	V_{DSS}	65	Vdc
Gate-Source Voltage	V_{GS}	± 20	Vdc
Drain Current — Continuous	I_D	7	Adc
Total Device Dissipation @ $T_C = 25^\circ\text{C}$ Derate above 25°C	P_D	159 0.9	Watts W/ $^\circ\text{C}$
Storage Temperature Range	T_{stg}	- 65 to +150	$^\circ\text{C}$
Operating Junction Temperature	T_J	200	$^\circ\text{C}$

THERMAL CHARACTERISTICS

Characteristic	Symbol	Value	Unit
Thermal Resistance, Junction to Case	$R_{\theta JC}$	1.1	$^\circ\text{C/W}$

NOTE - **CAUTION** - MOS devices are susceptible to damage from electrostatic charge. Reasonable precautions in handling and packaging MOS devices should be observed.

Freescale Semiconductor, Inc.

ELECTRICAL CHARACTERISTICS (T_C = 25°C unless otherwise noted)

Characteristic	Symbol	Min	Typ	Max	Unit
----------------	--------	-----	-----	-----	------

OFF CHARACTERISTICS

Drain-Source Breakdown Voltage (V _{GS} = 0 Vdc, I _D = 20 μAdc)	V _{(BR)DSS}	65	—	—	Vdc
Zero Gate Voltage Drain Current (V _{DS} = 28 Vdc, V _{GS} = 0 Vdc)	I _{DSS}	—	—	10	μAdc
Gate-Source Leakage Current (V _{GS} = 20 Vdc, V _{DS} = 0 Vdc)	I _{GSS}	—	—	1	μAdc

ON CHARACTERISTICS

Gate Threshold Voltage (V _{DS} = 10 Vdc, I _D = 300 μAdc)	V _{GS(th)}	2	3	4	Vdc
Gate Quiescent Voltage (V _{DS} = 26 Vdc, I _D = 400 mAdc)	V _{GS(Q)}	3	4	5	Vdc
Drain-Source On-Voltage (V _{GS} = 10 Vdc, I _D = 1 Adc)	V _{DS(on)}	—	0.15	0.6	Vdc
Forward Transconductance (V _{DS} = 10 Vdc, I _D = 2 Adc)	g _{fs}	2	3	—	S

DYNAMIC CHARACTERISTICS

Input Capacitance (1) (V _{DS} = 26 Vdc, V _{GS} = 0, f = 1 MHz)	C _{iss}	—	130	—	pF
Output Capacitance (V _{DS} = 26 Vdc, V _{GS} = 0, f = 1 MHz)	C _{oss}	41	47	52	pF
Reverse Transfer Capacitance (V _{DS} = 26 Vdc, V _{GS} = 0, f = 1 MHz)	C _{rss}	2.4	3	3.4	pF

FUNCTIONAL TESTS (In Motorola Test Fixture)

Output Power (2) (V _{DD} = 26 Vdc, I _{DQ} = 400 mA, f = Full GSM Band 921 - 960 MHz)	P _{1dB}	73	80	—	W
Common-Source Amplifier Power Gain @ P _{1dB} (Min) (2) (V _{DD} = 26 Vdc, I _{DQ} = 400 mA, f = Full GSM Band 921 - 960 MHz)	G _{ps}	14	16	18	dB
Drain Efficiency @ P _{out} = 50 W (V _{DD} = 26 Vdc, I _{DQ} = 400 mA, f = Full GSM Band 921 - 960 MHz)	η ₁	47	51	—	%
Drain Efficiency @ P _{1dB} (2) (V _{DD} = 26 Vdc, I _{DQ} = 400 mA, f = Full GSM Band 921 - 960 MHz)	η ₂	—	58	—	%
Input Return Loss @ P _{out} = 50 W (V _{DD} = 26 Vdc, I _{DQ} = 400 mA, f = 921 MHz and 960 MHz f = 940 MHz)	IRL	— —	— —	- 10 - 15	dB
Output Mismatch Stress (2) (V _{DD} = 26 Vdc, I _{DQ} = 400 mA, f = Full GSM Band 921 - 960 MHz, VSWR = 5:1, All Phase Angles)	Ψ	No Degradation In Output Power Before and After Test			

(1) Value excludes the input matching.

(2) To meet application requirements, Motorola test fixtures have been designed to cover full GSM 900 band ensuring batch-to-batch consistency.

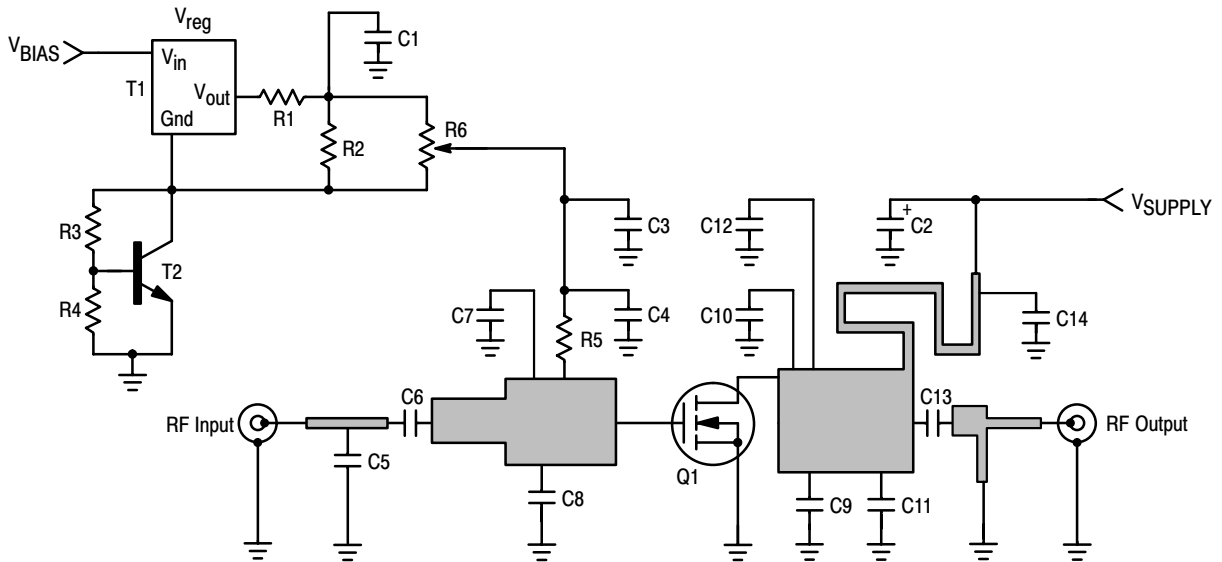

- | | | | |
|-------------|---------------------------------------|----|-------------------------------------|
| C1 | 1.0 μ F Chip Capacitor (0805) | R3 | 1.2 k Ω Chip Resistor (0805) |
| C2 | 10 μ F, 35 Vdc Tantalum Capacitor | R4 | 2.2 k Ω Chip Resistor (0805) |
| C3 | 100 nF Chip Capacitor | R5 | 220 Ω Chip Resistor (0805) |
| C4, C6, C14 | 22 pF Chip Capacitors, ACCU-P (0805) | R6 | 5.0 k Ω SMD Potentiometer |
| C5 | 2.7 pF Chip Capacitor, ACCU-P (0805) | T1 | LP2951 Micro-8 |
| C7, C8, C13 | 4.7 pF Chip Capacitors, ACCU-P (0805) | T2 | BC847 SOT-23 |
| C9, C10 | 8.2 pF Chip Capacitors, ACCU-P (0805) | | |
| C11, C12 | 2.2 pF Chip Capacitors, ACCU-P (0805) | | |
| R1 | 10 Ω Chip Resistor (0805) | | |
| R2 | 1.0 k Ω Chip Resistor (0805) | | |
- SUBSTRATE GI180 0.8 mm

Figure 1. MRF6522-70 Test Circuit Schematic

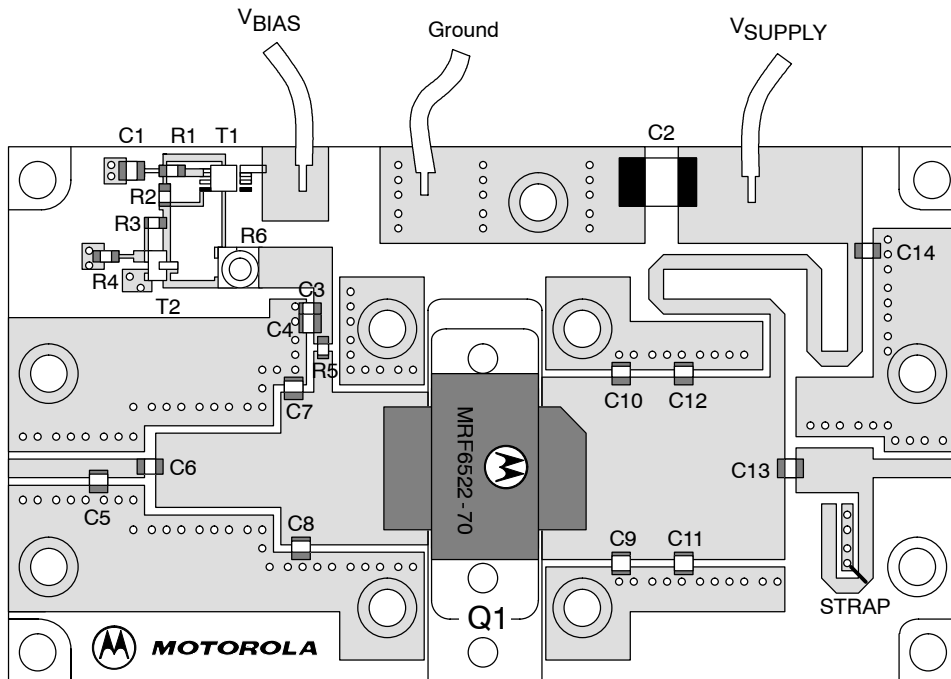

Figure 2. MRF6522-70 Test Circuit Component Layout

TYPICAL CHARACTERISTICS

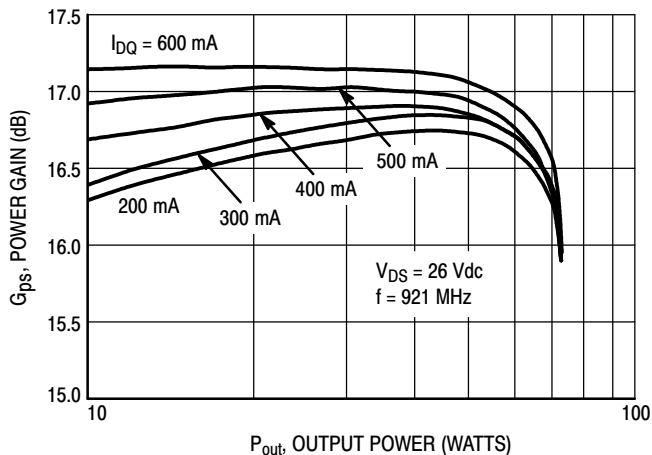

Figure 3. Power Gain versus Output Power

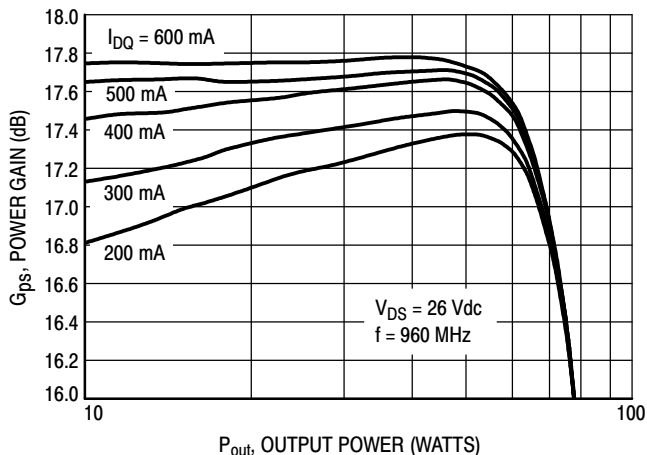

Figure 4. Power Gain versus Output Power

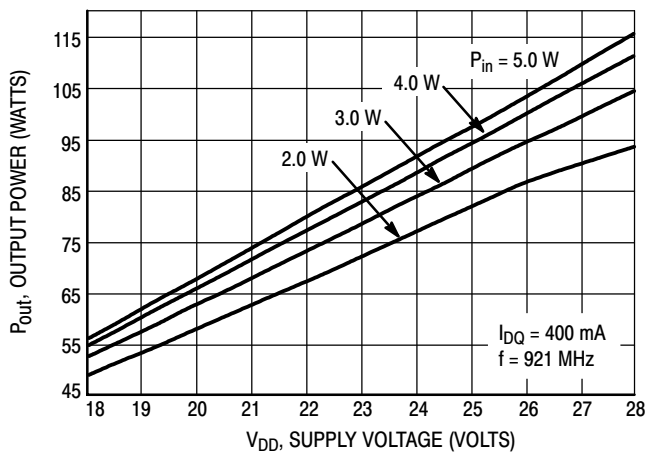

Figure 5. Output Power versus Supply Voltage

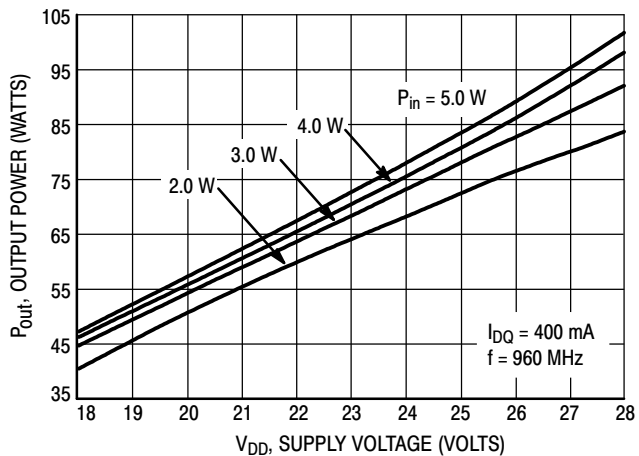

Figure 6. Output Power versus Supply Voltage

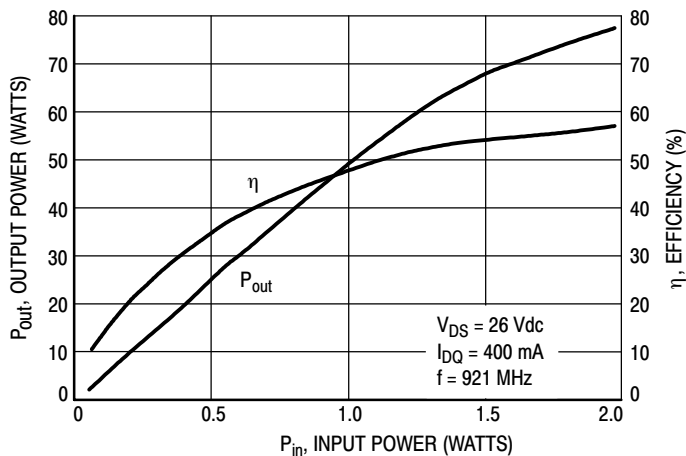

Figure 7. Efficiency and Output Power versus Input Power

Freescale Semiconductor, Inc.

TYPICAL CHARACTERISTICS

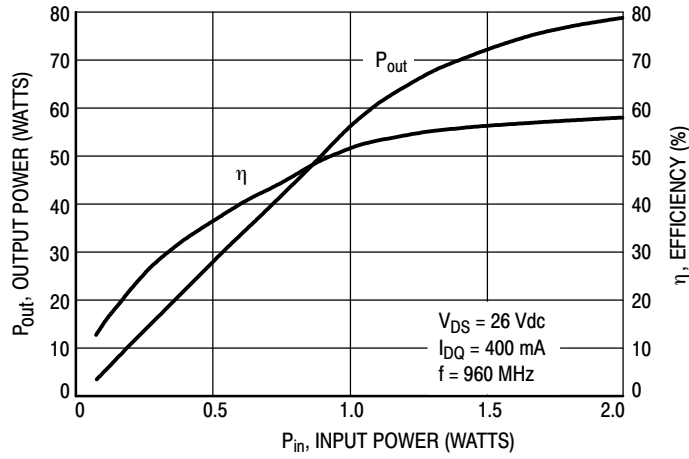

Figure 8. Efficiency and Output Power versus Input Power

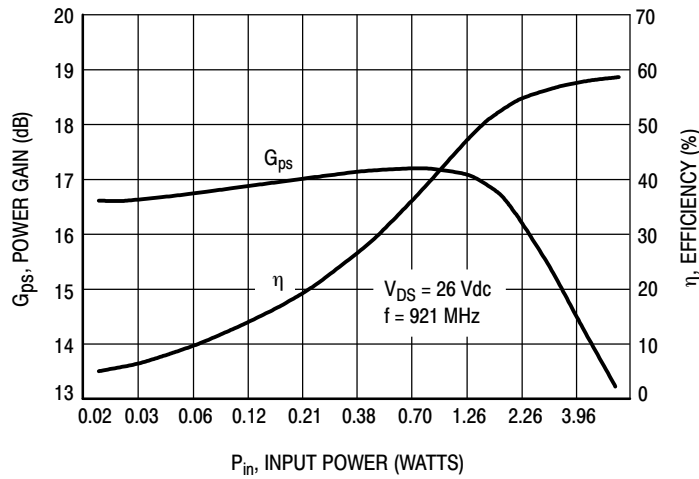

Figure 9. Power Gain and Efficiency versus Input Power

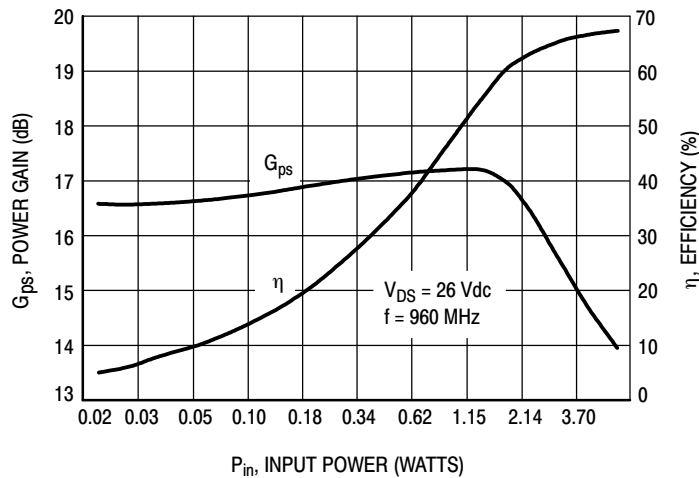

Figure 10. Power Gain and Efficiency versus Input Power

Freescale Semiconductor, Inc.

TYPICAL CHARACTERISTICS

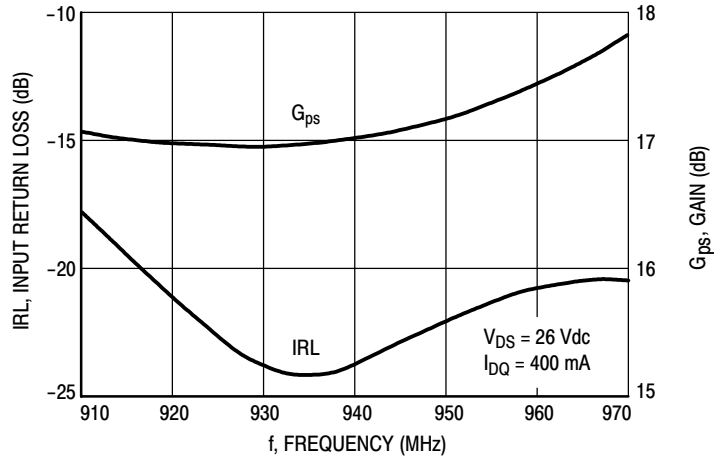
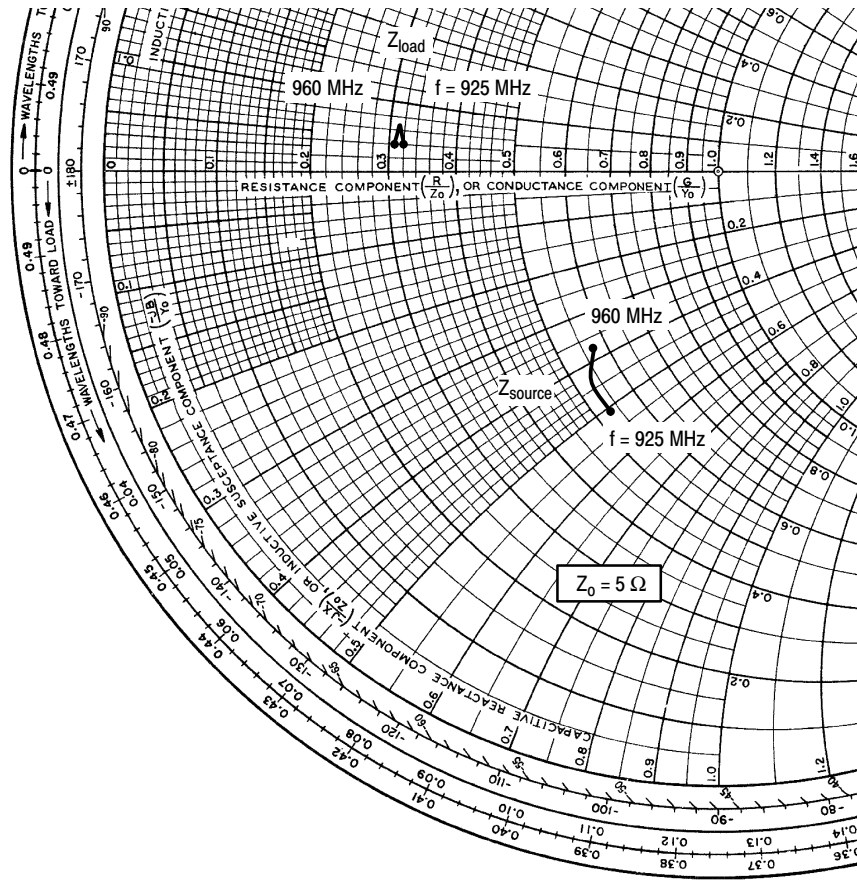

Figure 11. Performance in Broadband Circuit (at Small Signal)



V_{SUPPLY} = 26 Vdc, I_{BIAS} = 400 mA, CW = Room Temperature

f MHz	Z _{source} Ω	Z _{load} Ω
925	2.65 - j2.53	1.62 + j0.2
940	2.67 - j2.14	1.56 + j0.34
960	2.85 - j1.87	1.55 + j0.2

Z_{source} = Test circuit impedance as measured from gate to ground.

Z_{load} = Test circuit impedance as measured from drain to ground.

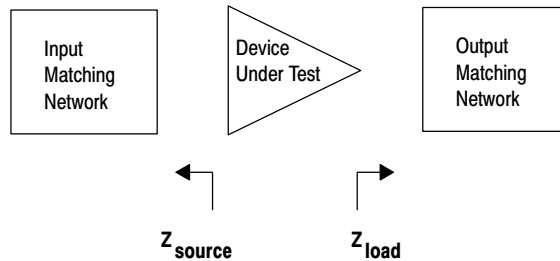
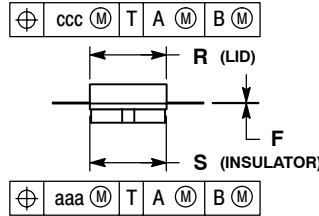
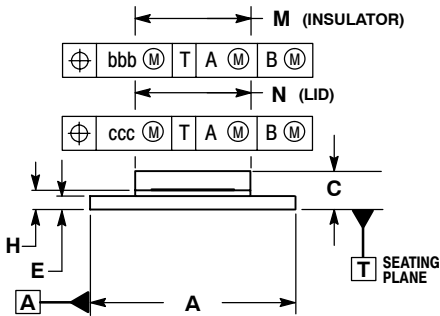
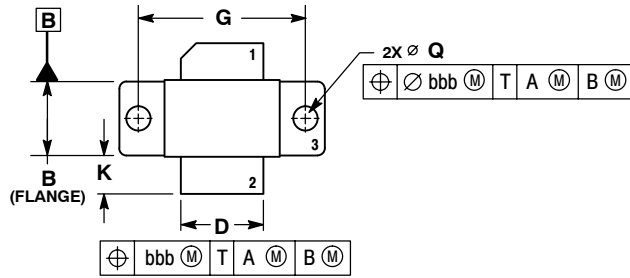

Figure 12. Series Equivalent Source and Load Impedance

Freescale Semiconductor, Inc.

PACKAGE DIMENSIONS



**CASE 465D-05
ISSUE D
NI-600**

NOTES:

1. INTERPRET DIMENSIONS AND TOLERANCES PER ANSI Y14.5M-1994.
2. CONTROLLING DIMENSION: INCH.
3. DIMENSION H IS MEASURED 0.030 (0.762) AWAY FROM PACKAGE BODY.

DIM	INCHES		MILLIMETERS	
	MIN	MAX	MIN	MAX
A	1.065	1.075	27.05	27.30
B	0.380	0.390	9.65	9.91
C	0.160	0.205	4.06	5.21
D	0.425	0.435	10.80	11.05
E	0.060	0.070	1.52	1.78
F	0.004	0.006	0.10	0.15
G	0.870 BSC		22.10 BSC	
H	0.096	0.106	2.44	2.69
K	0.190	0.223	4.83	5.66
M	0.594	0.606	15.09	15.39
N	0.591	0.601	15.01	15.27
Q	0.124	0.130	3.15	3.30
R	0.394	0.404	10.01	10.26
S	0.395	0.405	10.03	10.29
aaa	0.005 REF		0.13 REF	
bbb	0.010 REF		0.25 REF	
ccc	0.015 REF		0.38 REF	

STYLE 1:

1. DRAIN
2. GATE
3. SOURCE

Information in this document is provided solely to enable system and software implementers to use Motorola products. There are no express or implied copyright licenses granted hereunder to design or fabricate any integrated circuits or integrated circuits based on the information in this document.

Motorola reserves the right to make changes without further notice to any products herein. Motorola makes no warranty, representation or guarantee regarding the suitability of its products for any particular purpose, nor does Motorola assume any liability arising out of the application or use of any product or circuit, and specifically disclaims any and all liability, including without limitation consequential or incidental damages. "Typical" parameters that may be provided in Motorola data sheets and/or specifications can and do vary in different applications and actual performance may vary over time. All operating parameters, including "Typicals", must be validated for each customer application by customer's technical experts. Motorola does not convey any license under its patent rights nor the rights of others. Motorola products are not designed, intended, or authorized for use as components in systems intended for surgical implant into the body, or other applications intended to support or sustain life, or for any other application in which the failure of the Motorola product could create a situation where personal injury or death may occur. Should Buyer purchase or use Motorola products for any such unintended or unauthorized application, Buyer shall indemnify and hold Motorola and its officers, employees, subsidiaries, affiliates, and distributors harmless against all claims, costs, damages, and expenses, and reasonable attorney fees arising out of, directly or indirectly, any claim of personal injury or death associated with such unintended or unauthorized use, even if such claim alleges that Motorola was negligent regarding the design or manufacture of the part.

MOTOROLA and the Stylized M Logo are registered in the US Patent and Trademark Office. All other product or service names are the property of their respective owners. Motorola, Inc. is an Equal Opportunity/Affirmative Action Employer.

© Motorola Inc. 2004

HOW TO REACH US:

USA/EUROPE/LOCATIONS NOT LISTED:
Motorola Literature Distribution
P.O. Box 5405, Denver, Colorado 80217
1-800-521-6274 or 480-768-2130

JAPAN: Motorola Japan Ltd.; SPS, Technical Information Center,
3-20-1, Minami-Azabu, Minato-ku, Tokyo 106-8573, Japan
81-3-3440-3569

ASIA/PACIFIC: Motorola Semiconductors H.K. Ltd.; Silicon Harbour Centre,
2 Dai King Street, Tai Po Industrial Estate, Tai Po, N.T., Hong Kong
852-26668334

HOME PAGE: <http://motorola.com/semiconductors>



**For More Information On This Product,
Go to: www.freescale.com**

MRF6522-70/D

Freescale Semiconductor, Inc.