

MC74AC574, MC74ACT574

Octal D Flip-Flop with 3-State Outputs

The MC74AC574/74ACT574 is a high-speed, low power octal flip-flop with a buffered common Clock (CP) and a buffered common Output Enable (OE). The information presented to the D inputs is stored in the flip-flops on the LOW-to-HIGH Clock (CP) transition.

The MC74AC574/74ACT574 is functionally identical to the MC74AC374/74ACT374 except for the pinouts.

- Inputs and Outputs on Opposite Sides of Package Allowing Easy Interface with Microprocessors
- Useful as Input or Output Port for Microprocessors
- Functionally Identical to MC74AC374/74ACT374
- 3-State Outputs for Bus-Oriented Applications
- Outputs Source/Sink 24 mA
- 'ACT574 Has TTL Compatible Inputs

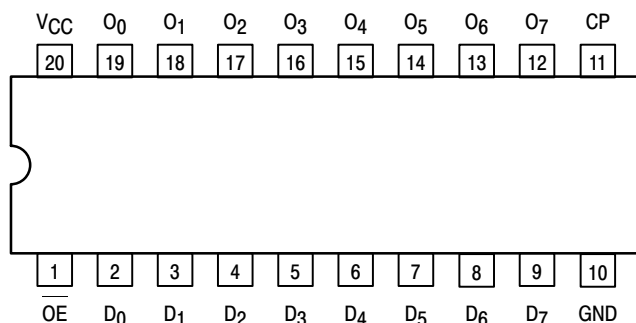

Figure 1. Pinout: 20-Lead Packages Conductors (Top View)

PIN ASSIGNMENT

PIN	FUNCTION
D ₀ -D ₇	Data Inputs
CP	Clock Pulse Input
OE	3-State Output Enable Input
O ₀ -O ₇	3-State Outputs



ON Semiconductor™

<http://onsemi.com>

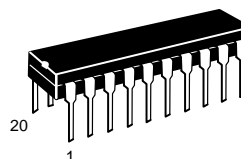

PDIP-20
N SUFFIX
CASE 738

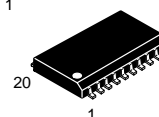

SO-20
DW SUFFIX
CASE 751

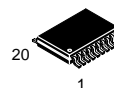

TSSOP-20
DT SUFFIX
CASE 948E

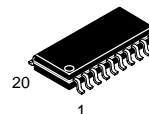

EIAJ-20
M SUFFIX
CASE 967

ORDERING INFORMATION

Device	Package	Shipping
MC74AC574N	PDIP-20	18 Units/Rail
MC74ACT574N	PDIP-20	18 Units/Rail
MC74AC574DW	SOIC-20	38 Units/Rail
MC74AC574DWR2	SOIC-20	1000 Tape & Reel
MC74ACT574DW	SOIC-20	38 Units/Rail
MC74ACT574DWR2	SOIC-20	1000 Tape & Reel
MC74AC574DT	TSSOP-20	75 Units/Rail
MC74AC574DTR2	TSSOP-20	2500 Tape & Reel
MC74ACT574DT	TSSOP-20	75 Units/Rail
MC74ACT574DTR2	TSSOP-20	2500 Tape & Reel
MC74AC574M	EIAJ-20	40 Units/Rail
MC74AC574MEL	EIAJ-20	2000 Tape & Reel
MC74ACT574M	EIAJ-20	40 Units/Rail
MC74ACT574MEL	EIAJ-20	2000 Tape & Reel

DEVICE MARKING INFORMATION

See general marking information in the device marking section on page 8 of this data sheet.

MC74AC574, MC74ACT574

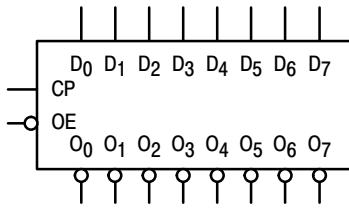

Figure 2. Logic Symbol

FUNCTIONAL DESCRIPTION

The MC74AC574/74ACT574 consists of eight edge-triggered flip-flops with individual D-type inputs and 3-state true outputs. The buffered clock and buffered Output Enable are common to all flip-flops. The eight flip-flops will store the state of their individual D inputs that meet the setup and hold time requirements on the LOW-to-HIGH Clock (CP) transition. With the Output Enable (OE) LOW, the contents of the eight flip-flops are available at the outputs. When OE is HIGH, the outputs go to the high impedance state. Operation of the OE input does not affect the state of the flip-flops.

FUNCTION TABLE

Inputs			Internal	Outputs	Function
OE	CP	D	Q	O _n	
H	H	L	NC	Z	Hold
H	H	H	NC	Z	Hold
H	⌋	L	L	Z	Load
H	⌋	H	H	Z	Load
L	⌋	L	L	L	Data Available
L	⌋	H	H	H	Data Available
L	H	L	NC	NC	No Change in Data
L	H	H	NC	NC	No Change in Data

H = HIGH Voltage Level
 L = LOW Voltage Level
 X = Immaterial
 Z = High Impedance
 ⌋ = LOW-to-HIGH Clock Transition
 NC = No Change

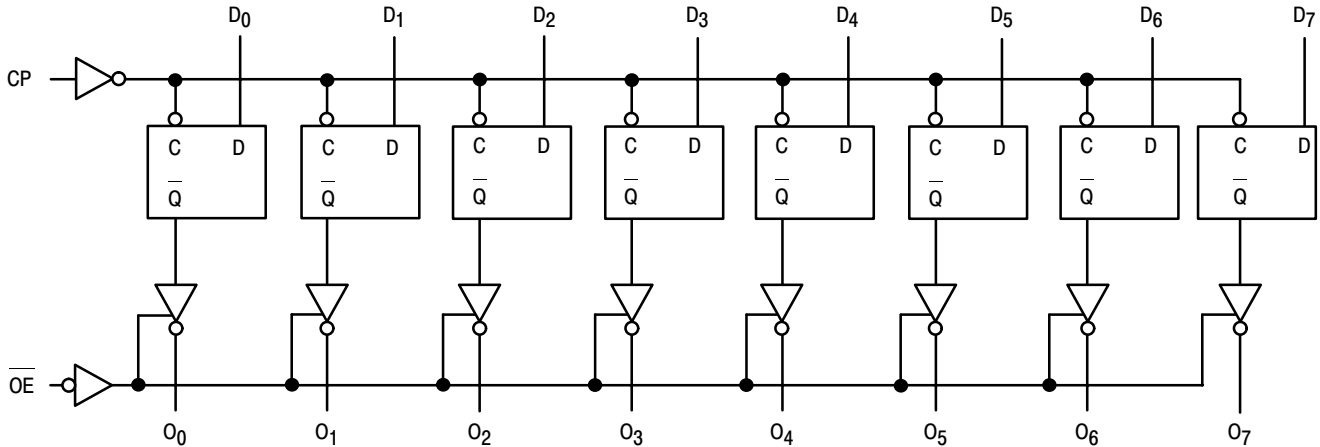

NOTE: This diagram is provided only for the understanding of logic operations and should not be used to estimate propagation delays.

Figure 3. Logic Diagram

MAXIMUM RATINGS*

Symbol	Parameter	Value	Unit
V _{CC}	DC Supply Voltage (Referenced to GND)	-0.5 to +7.0	V
V _{IN}	DC Input Voltage (Referenced to GND)	-0.5 to V _{CC} +0.5	V
V _{OUT}	DC Output Voltage (Referenced to GND)	-0.5 to V _{CC} +0.5	V
I _{IN}	DC Input Current, per Pin	±20	mA
I _{OUT}	DC Output Sink/Source Current, per Pin	±50	mA
I _{CC}	DC V _{CC} or GND Current per Output Pin	±50	mA
T _{stg}	Storage Temperature	-65 to +150	°C

* Maximum Ratings are those values beyond which damage to the device may occur. Functional operation should be restricted to the Recommended Operating Conditions.

MC74AC574, MC74ACT574

RECOMMENDED OPERATING CONDITIONS

Symbol	Parameter	Min	Typ	Max	Unit	
V _{CC}	Supply Voltage	'AC	2.0	5.0	6.0	V
		'ACT	4.5	5.0	5.5	
V _{IN} , V _{OUT}	DC Input Voltage, Output Voltage (Ref. to GND)	0	–	V _{CC}	V	
t _r , t _f	Input Rise and Fall Time (Note 1) 'AC Devices except Schmitt Inputs	V _{CC} @ 3.0 V	–	150	–	ns/V
		V _{CC} @ 4.5 V	–	40	–	
		V _{CC} @ 5.5 V	–	25	–	
t _r , t _f	Input Rise and Fall Time (Note 2) 'ACT Devices except Schmitt Inputs	V _{CC} @ 4.5 V	–	10	–	ns/V
		V _{CC} @ 5.5 V	–	8.0	–	
T _J	Junction Temperature (PDIP)	–	–	140	°C	
T _A	Operating Ambient Temperature Range	–40	25	85	°C	
I _{OH}	Output Current – High	–	–	–24	mA	
I _{OL}	Output Current – Low	–	–	24	mA	

1. V_{IN} from 30% to 70% V_{CC}; see individual Data Sheets for devices that differ from the typical input rise and fall times.
2. V_{IN} from 0.8 V to 2.0 V; see individual Data Sheets for devices that differ from the typical input rise and fall times.

MC74AC574, MC74ACT574

DC CHARACTERISTICS

Symbol	Parameter	V _{CC} (V)	74AC		74AC	Unit	Conditions
			T _A = +25°C		T _A = -40°C to +85°C		
			Typ	Guaranteed Limits			
V _{IH}	Minimum High Level Input Voltage	3.0	1.5	2.1	2.1	V	V _{OUT} = 0.1 V or V _{CC} - 0.1 V
		4.5	2.25	3.15	3.15		
		5.5	2.75	3.85	3.85		
V _{IL}	Maximum Low Level Input Voltage	3.0	1.5	0.9	0.9	V	V _{OUT} = 0.1 V or V _{CC} - 0.1 V
		4.5	2.25	1.35	1.35		
		5.5	2.75	1.65	1.65		
V _{OH}	Minimum High Level Output Voltage	3.0	2.99	2.9	2.9	V	I _{OUT} = -50 μA
		4.5	4.49	4.4	4.4		
		5.5	5.49	5.4	5.4		
		3.0	-	2.56	2.46	V	*V _{IN} = V _{IL} or V _{IH} -12 mA I _{OH} -24 mA -24 mA
		4.5	-	3.86	3.76		
		5.5	-	4.86	4.76		
V _{OL}	Maximum Low Level Output Voltage	3.0	0.002	0.1	0.1	V	I _{OUT} = 50 μA
		4.5	0.001	0.1	0.1		
		5.5	0.001	0.1	0.1		
		3.0	-	0.36	0.44	V	*V _{IN} = V _{IL} or V _{IH} 12 mA I _{OL} 24 mA 24 mA
		4.5	-	0.36	0.44		
		5.5	-	0.36	0.44		
I _{IN}	Maximum Input Leakage Current	5.5	-	±0.1	±1.0	μA	V _I = V _{CC} , GND
I _{OLD}	†Minimum Dynamic Output Current	5.5	-	-	75	mA	V _{OLD} = 1.65 V Max
I _{OHD}		5.5	-	-	-75	mA	V _{OHD} = 3.85 V Min
I _{CC}	Maximum Quiescent Supply Current	5.5	-	8.0	80	μA	V _{IN} = V _{CC} or GND

* All outputs loaded; thresholds on input associated with output under test.

†Maximum test duration 2.0 ms, one output loaded at a time.

NOTE: Note: I_{IN} and I_{CC} @ 3.0 V are guaranteed to be less than or equal to the respective limit @ 5.5 V V_{CC}.

MC74AC574, MC74ACT574

AC CHARACTERISTICS (For Figures and Waveforms — See Section 3)

Symbol	Parameter	V _{CC} * (V)	74AC			74AC		Unit	Fig. No.
			T _A = +25°C C _L = 50 pF			T _A = -40°C to +85°C C _L = 50 pF			
			Min	Typ	Max	Min	Max		
f _{max}	Maximum Clock Frequency	3.3 5.0	75 95	— —	— —	60 85	— —	MHz	3-3
t _{PLH}	Propagation Delay CP to O _n	3.3 5.0	3.5 2.0	— —	13.5 9.5	3.5 2.0	15 11	ns	3-6
t _{PHL}	Propagation Delay CP to O _n	3.3 5.0	3.5 2.0	— —	12 8.5	3.5 2.0	13.5 9.5	ns	3-6
t _{PZH}	Output Enable Time	3.3 5.0	2.5 2.0	— —	11 8.5	2.5 2.0	12 9.0	ns	3-7
t _{PZL}	Output Enable Time	3.3 5.0	3.0 1.5	— —	10.5 8.0	3.5 2.0	11.5 9.0	ns	3-8
t _{PHZ}	Output Disable Time	3.3 5.0	4.0 2.0	— —	12 9.5	4.5 2.0	13 10.5	ns	3-7
t _{PLZ}	Output Disable Time	3.3 5.0	2.0 1.5	— —	9.0 7.5	2.5 1.5	10 8.5	ns	3-8

* Voltage Range 3.3 V is 3.3 V ±0.3 V.
Voltage Range 5.0 V is 5.0 V ±0.5 V.

AC OPERATING REQUIREMENTS

Symbol	Parameter	V _{CC} * (V)	74AC		74AC		Unit	Fig. No.
			T _A = +25°C C _L = 50 pF		T _A = -40°C to +85°C C _L = 50 pF			
			Typ	Guaranteed Minimum				
t _s	Setup Time, HIGH or LOW D _n to CP	3.3 5.0	— —	2.5 1.5	3.0 2.0	ns	3-9	
t _h	Hold Time, HIGH or LOW D _n to CP	3.3 5.0	— —	1.5 1.5	1.5 1.5	ns	3-9	
t _w	CP Pulse Width HIGH or LOW	3.3 5.0	— —	6.0 4.0	7.0 5.0	ns	3-6	

*Voltage Range 3.3 V is 3.3 V ±0.3 V.
Voltage Range 5.0 V is 5.0 V ±0.5 V.

MC74AC574, MC74ACT574

DC CHARACTERISTICS

Symbol	Parameter	V _{CC} (V)	74ACT		74ACT		Unit	Conditions
			T _A = +25°C		T _A = -40°C to +85°C			
			Typ	Guaranteed Limits				
V _{IH}	Minimum High Level Input Voltage	4.5	1.5	2.0	2.0	V	V _{OUT} = 0.1 V or V _{CC} - 0.1 V	
		5.5	1.5	2.0	2.0			
V _{IL}	Maximum Low Level Input Voltage	4.5	1.5	0.8	0.8	V	V _{OUT} = 0.1 V or V _{CC} - 0.1 V	
		5.5	1.5	0.8	0.8			
V _{OH}	Minimum High Level Output Voltage	4.5	4.49	4.4	4.4	V	I _{OUT} = -50 μA	
		5.5	5.49	5.4	5.4			
		4.5	-	3.86	3.76	V	*V _{IN} = V _{IL} or V _{IH} I _{OH} = -24 mA	
		5.5	-	4.86	4.76			
V _{OL}	Maximum Low Level Output Voltage	4.5	0.001	0.1	0.1	V	I _{OUT} = 50 μA	
		5.5	0.001	0.1	0.1			
		4.5	-	0.36	0.44	V	*V _{IN} = V _{IL} or V _{IH} I _{OL} = 24 mA	
		5.5	-	0.36	0.44			
I _{IN}	Maximum Input Leakage Current	5.5	-	±0.1	±1.0	μA	V _I = V _{CC} , GND	
ΔI _{CCT}	Additional Max. I _{CC} /Input	5.5	0.6		1.5	mA	V _I = V _{CC} - 2.1 V	
I _{OZ}	Maximum 3-State Current	5.5	-	±0.5	±5.0	μA	V _I (OE) = V _{IL} , V _{IH} V _I = V _{CC} , GND V _O = V _{CC} , GND	
I _{OLD}	†Minimum Dynamic Output Current	5.5	-	-	75	mA	V _{OLD} = 1.65 V Max	
I _{OHD}		5.5	-	-	-75	mA	V _{OHD} = 3.85 V Min	
I _{CC}	Maximum Quiescent Supply Current	5.5	-	8.0	80	μA	V _{IN} = V _{CC} or GND	

*All outputs loaded; thresholds on input associated with output under test.

†Maximum test duration 2.0 ms, one output loaded at a time.

AC CHARACTERISTICS (For Figures and Waveforms — See Section 3)

Symbol	Parameter	V _{CC} * (V)	74ACT			74ACT		Unit	Fig. No.
			T _A = +25°C C _L = 50 pF			T _A = -40°C to +85°C C _L = 50 pF			
			Min	Typ	Max	Min	Max		
f _{max}	Maximum Clock Frequency	5.0	100	-	-	85	-	ns	3-3
t _{PLH}	Propagation Delay CP to O _n	5.0	2.5	-	11	2.0	12	ns	3-6
t _{PHL}	Propagation Delay CP to O _n	5.0	2.0	-	10	1.5	11	ns	3-6
t _{PZH}	Output Enable Time	5.0	2.0	-	9.5	1.5	10	ns	3-7
t _{PZL}	Output Enable Time	5.0	2.0	-	9.0	1.5	10	ns	3-8
t _{PHZ}	Output Disable Time	5.0	2.0	-	10.5	1.5	11.5	ns	3-7
t _{PLZ}	Output Disable Time	5.0	2.0	-	8.5	1.5	9.0	ns	3-8

*Voltage Range 5.0 V is 5.0 V ±0.5 V.

MC74AC574, MC74ACT574

AC OPERATING REQUIREMENTS

Symbol	Parameter	V _{CC} * (V)	74ACT		74ACT		Unit	Fig. No.
			T _A = +25°C C _L = 50 pF		T _A = -40°C to +85°C C _L = 50 pF			
			Typ	Guaranteed Minimum				
t _s	Setup Time, HIGH or LOW D _n to CP	5.0	–	2.5	2.5	ns	3–9	
t _h	Hold Time, HIGH or LOW D _n to CP	5.0	–	1.0	1.0	ns	3–9	
t _w	CP Pulse Width HIGH or LOW	5.0	–	3.0	4.0	ns	3–6	

*Voltage Range 3.3 V is 3.3 V ±0.3 V.
Voltage Range 5.0 V is 5.0 V ±0.5 V.

CAPACITANCE

Symbol	Parameter	Value Typ	Unit	Test Conditions
C _{IN}	Input Capacitance	4.5	pF	V _{CC} = 5.0 V
C _{PD}	Power Dissipation Capacitance	40	pF	V _{CC} = 5.0 V

MC74AC574, MC74ACT574

MARKING DIAGRAMS

PDIP-20



SO-20



TSSOP-20

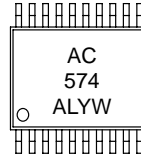

EIAJ-20

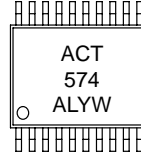
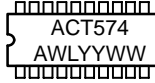

A = Assembly Location
WL, L = Wafer Lot
YY, Y = Year
WW, W = Work Week

MC74AC574, MC74ACT574

PACKAGE DIMENSIONS

PDIP-20
N SUFFIX
 20 PIN PLASTIC DIP PACKAGE
 CASE 738-03
 ISSUE E

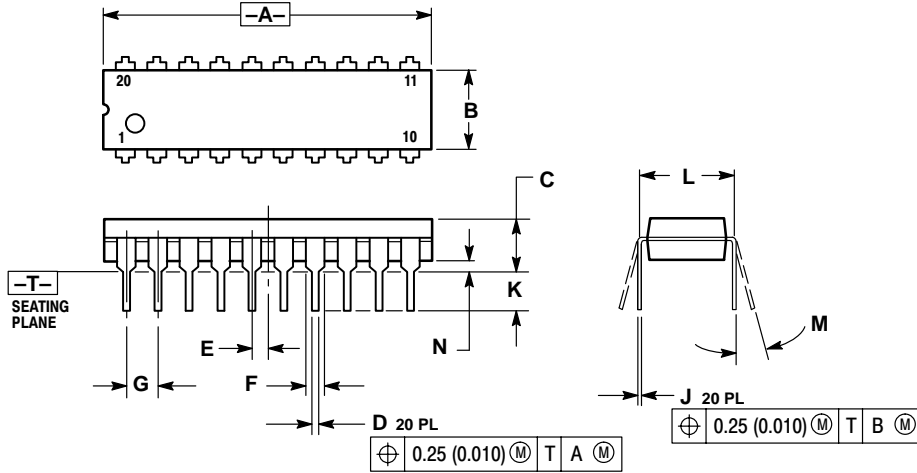

- NOTES:
1. DIMENSIONING AND TOLERANCING PER ANSI Y14.5M, 1982.
 2. CONTROLLING DIMENSION: INCH.
 3. DIMENSION L TO CENTER OF LEAD WHEN FORMED PARALLEL.
 4. DIMENSION B DOES NOT INCLUDE MOLD FLASH.

DIM	INCHES		MILLIMETERS	
	MIN	MAX	MIN	MAX
A	1.010	1.070	25.66	27.17
B	0.240	0.260	6.10	6.60
C	0.150	0.180	3.81	4.57
D	0.015	0.022	0.39	0.55
E	0.050 BSC		1.27 BSC	
F	0.050	0.070	1.27	1.77
G	0.100 BSC		2.54 BSC	
J	0.008	0.015	0.21	0.38
K	0.110	0.140	2.80	3.55
L	0.300 BSC		7.62 BSC	
M	0°	15°	0°	15°
N	0.020	0.040	0.51	1.01

SO-20
DW SUFFIX
 20 PIN PLASTIC SOIC PACKAGE
 CASE 751D-05
 ISSUE F

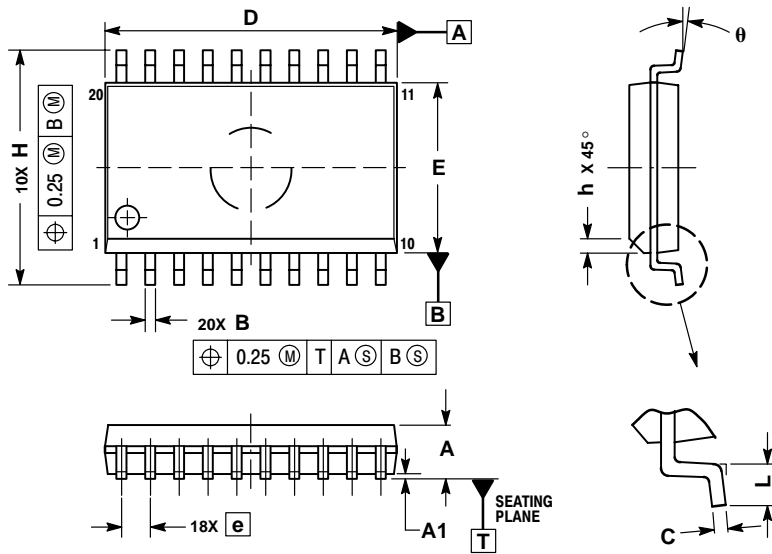

- NOTES:
1. DIMENSIONS ARE IN MILLIMETERS.
 2. INTERPRET DIMENSIONS AND TOLERANCES PER ASME Y14.5M, 1994.
 3. DIMENSIONS D AND E DO NOT INCLUDE MOLD PROTRUSION.
 4. MAXIMUM MOLD PROTRUSION 0.15 PER SIDE.
 5. DIMENSION B DOES NOT INCLUDE DAMBAR PROTRUSION. ALLOWABLE PROTRUSION SHALL BE 0.13 TOTAL IN EXCESS OF B DIMENSION AT MAXIMUM MATERIAL CONDITION.

DIM	MILLIMETERS	
	MIN	MAX
A	2.35	2.65
A1	0.10	0.25
B	0.35	0.49
C	0.23	0.32
D	12.65	12.95
E	7.40	7.60
e	1.27 BSC	
H	10.05	10.55
h	0.25	0.75
L	0.50	0.90
θ	0°	7°

MC74AC574, MC74ACT574

PACKAGE DIMENSIONS

TSSOP-20
DT SUFFIX
 20 PIN PLASTIC TSSOP PACKAGE
 CASE 948E-02
 ISSUE A

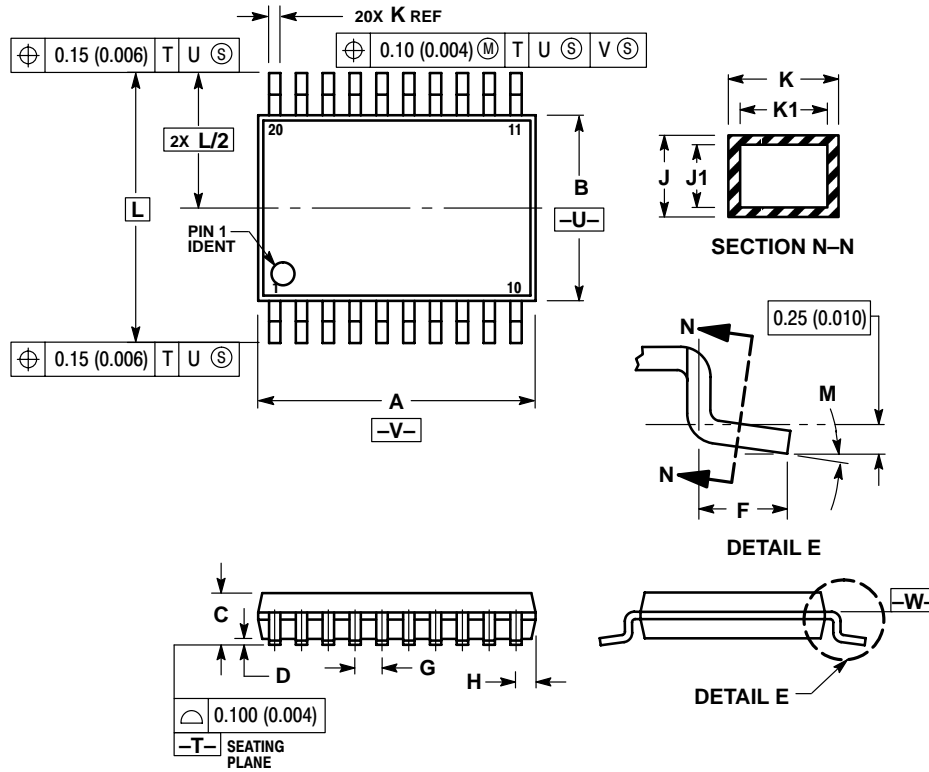

NOTES:

1. DIMENSIONING AND TOLERANCING PER ANSI Y14.5M, 1982.
2. CONTROLLING DIMENSION: MILLIMETER.
3. DIMENSION A DOES NOT INCLUDE MOLD FLASH, PROTRUSIONS OR GATE BURRS. MOLD FLASH OR GATE BURRS SHALL NOT EXCEED 0.15 (0.006) PER SIDE.
4. DIMENSION B DOES NOT INCLUDE INTERLEAD FLASH OR PROTRUSION. INTERLEAD FLASH OR PROTRUSION SHALL NOT EXCEED 0.25 (0.010) PER SIDE.
5. DIMENSION K DOES NOT INCLUDE DAMBAR PROTRUSION. ALLOWABLE DAMBAR PROTRUSION SHALL BE 0.08 (0.003) TOTAL IN EXCESS OF THE K DIMENSION AT MAXIMUM MATERIAL CONDITION.
6. TERMINAL NUMBERS ARE SHOWN FOR REFERENCE ONLY.
7. DIMENSION A AND B ARE TO BE DETERMINED AT DATUM PLANE -W-.

EIAJ-20
M SUFFIX
 20 PIN PLASTIC EIAJ PACKAGE
 CASE 967-01
 ISSUE O

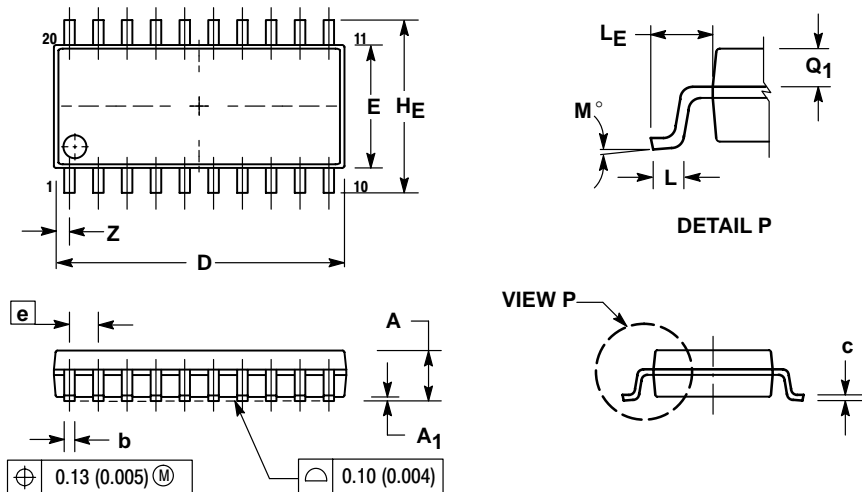

NOTES:

1. DIMENSIONING AND TOLERANCING PER ANSI Y14.5M, 1982.
2. CONTROLLING DIMENSION: MILLIMETER.
3. DIMENSIONS D AND E DO NOT INCLUDE MOLD FLASH OR PROTRUSIONS AND ARE MEASURED AT THE PARTING LINE. MOLD FLASH OR PROTRUSIONS SHALL NOT EXCEED 0.15 (0.006) PER SIDE.
4. TERMINAL NUMBERS ARE SHOWN FOR REFERENCE ONLY.
5. THE LEAD WIDTH DIMENSION (b) DOES NOT INCLUDE DAMBAR PROTRUSION. ALLOWABLE DAMBAR PROTRUSION SHALL BE 0.08 (0.003) TOTAL IN EXCESS OF THE LEAD WIDTH DIMENSION AT MAXIMUM MATERIAL CONDITION. DAMBAR CANNOT BE LOCATED ON THE LOWER RADIUS OR THE FOOT. MINIMUM SPACE BETWEEN PROTRUSIONS AND ADJACENT LEAD TO BE 0.46 (0.018).

DIM	MILLIMETERS		INCHES	
	MIN	MAX	MIN	MAX
A	---	2.05	---	0.081
A1	0.05	0.20	0.002	0.008
b	0.35	0.50	0.014	0.020
c	0.18	0.27	0.007	0.011
D	12.35	12.80	0.486	0.504
E	5.10	5.45	0.201	0.215
e	1.27 BSC		0.050 BSC	
HE	7.40	8.20	0.291	0.323
L	0.50	0.85	0.020	0.033
LE	1.10	1.50	0.043	0.059
M	0°	10°	0°	10°
Q1	0.70	0.90	0.028	0.035
Z	---	0.81	---	0.032

Notes

MC74AC574, MC74ACT574

ON Semiconductor and  are trademarks of Semiconductor Components Industries, LLC (SCILLC). SCILLC reserves the right to make changes without further notice to any products herein. SCILLC makes no warranty, representation or guarantee regarding the suitability of its products for any particular purpose, nor does SCILLC assume any liability arising out of the application or use of any product or circuit, and specifically disclaims any and all liability, including without limitation special, consequential or incidental damages. "Typical" parameters which may be provided in SCILLC data sheets and/or specifications can and do vary in different applications and actual performance may vary over time. All operating parameters, including "Typicals" must be validated for each customer application by customer's technical experts. SCILLC does not convey any license under its patent rights nor the rights of others. SCILLC products are not designed, intended, or authorized for use as components in systems intended for surgical implant into the body, or other applications intended to support or sustain life, or for any other application in which the failure of the SCILLC product could create a situation where personal injury or death may occur. Should Buyer purchase or use SCILLC products for any such unintended or unauthorized application, Buyer shall indemnify and hold SCILLC and its officers, employees, subsidiaries, affiliates, and distributors harmless against all claims, costs, damages, and expenses, and reasonable attorney fees arising out of, directly or indirectly, any claim of personal injury or death associated with such unintended or unauthorized use, even if such claim alleges that SCILLC was negligent regarding the design or manufacture of the part. SCILLC is an Equal Opportunity/Affirmative Action Employer.

PUBLICATION ORDERING INFORMATION

Literature Fulfillment:

Literature Distribution Center for ON Semiconductor
P.O. Box 5163, Denver, Colorado 80217 USA
Phone: 303-675-2175 or 800-344-3860 Toll Free USA/Canada
Fax: 303-675-2176 or 800-344-3867 Toll Free USA/Canada
Email: ONlit@hibbertco.com

N. American Technical Support: 800-282-9855 Toll Free USA/Canada

JAPAN: ON Semiconductor, Japan Customer Focus Center
4-32-1 Nishi-Gotanda, Shinagawa-ku, Tokyo, Japan 141-0031
Phone: 81-3-5740-2700
Email: r14525@onsemi.com

ON Semiconductor Website: <http://onsemi.com>

For additional information, please contact your local Sales Representative.