

234-485 | 497 | 503 | 515

BTY79 SERIES

THYRISTORS



Glass-passivated silicon thyristors in metal envelopes, intended for use in power control circuits (e.g. light and motor control) and power switching systems.

The series consists of reverse polarity types (anode to stud) identified by a suffix R: BTY79-400R to 1000R.

QUICK REFERENCE DATA

	BTY79-400R	500R	600R	800R	1000R
Repetitive peak voltages V_{DRM}/V_{RRM} max.	400	500	600	800	1000 V
Average on-state current					$I_{T(AV)}$ max. 10 A
R.M.S. on-state current					$I_{T(RMS)}$ max. 16 A
Non-repetitive peak on-state current					I_{TSM} max. 150 A

MECHANICAL DATA

Dimensions in mm

Fig. 1 TO-64: with 10-32 UNF stud (ϕ 4,83 mm).

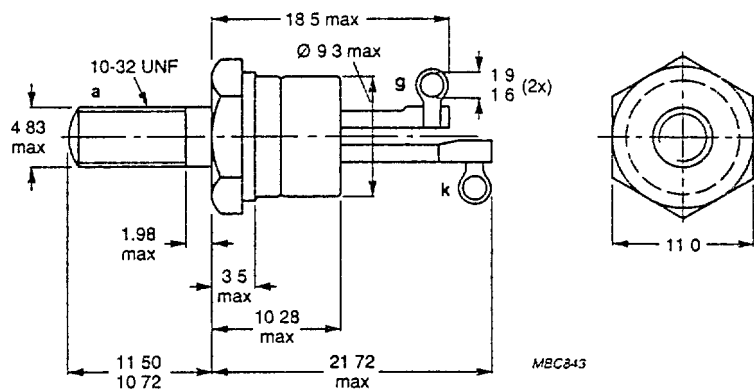

Net mass: 7 g
 Diameter of clearance hole: max. 5,2 mm
 Accessories supplied on request:
 see ACCESSORIES section

Torque on nut: min. 0,9 Nm
 (9 kg cm)
 max. 1,7 Nm
 (17 kg cm)

Supplied with device: 1 nut, 1 lock washer.
 Nut dimensions: across the flats: 9,5 mm.

Qualification approved to CECC 50 011-006.

BTY79 SERIES

RATINGS

Limiting values in accordance with the Absolute Maximum System (IEC 134)

Anode to cathode		BTY79-400R	500R	600R	800R	1000R
Non-repetitive peak off-state voltage ($t \leq 10$ ms)	V_{DSM}^{**} max.	500	1100	1100	1100	1100 V
Non-repetitive peak reverse voltage ($t \leq 5$ ms)	V_{RSM} max.	500	600	720	960	1100 V
Repetitive peak voltages	V_{DRM}/V_{RRM} max.	400	500	600	800	1000 V
Crest working voltages	V_{DWM}/V_{RWM} max.	400	500	600	800	1000 V*
Average on-state current (averaged over any 20 ms period) up to $T_{mb} = 85$ °C				$I_T(AV)$	max.	10 A
R.M.S. on-state current				$I_T(RMS)$	max.	16 A
Repetitive peak on-state current				I_{TRM}	max.	75 A
Non-repetitive peak on-state current; $t = 10$ ms; half sine-wave; $T_j = 125$ °C prior to surge; with reapplied V_{RWMmax}				I_{TSM}	max.	150 A
I^2t for fusing ($t = 10$ ms)				I^2t	max.	112 A ² s
Rate of rise of on-state current after triggering with $I_G = 150$ mA to $I_T = 30$ A; $dI_G/dt = 0,25$ A/ μ s				dI_T/dt	max.	50 A/ μ s
Gate to cathode						
Average power dissipation (averaged over any 20 ms period)				$P_G(AV)$	max.	0,5 W
Peak power dissipation				P_{GM}	max.	5 W
Temperatures						
Storage temperature				T_{stg}		-55 to +125 °C
Junction temperature				T_j	max.	125 °C
THERMAL RESISTANCE						
From junction to mounting base				$R_{th j-mb}$	=	1,8 °C/W
From mounting base to heatsink with heatsink compound				$R_{th mb-h}$	=	0,5 °C/W
From junction to ambient in free air				$R_{th j-a}$	=	45 °C/W
Transient thermal impedance ($t = 1$ ms)				$Z_{th j-mb}$	=	0,1 °C/W

* To ensure thermal stability: $R_{th j-a} < 4$ °C/W (d.c. blocking) or < 8 °C/W (a.c.). For smaller heat-sinks T_{jmax} should be derated. For a.c. see Fig. 3.

** Although not recommended, higher off-state voltages may be applied without damage, but the thyristor may switch into the on-state. The rate of rise of on-state current should not exceed 100 A/ μ s.

CHARACTERISTICS

Anode to cathode

On-state voltage (measured under pulse conditions)

$I_T = 20 \text{ A}; T_j = 25 \text{ }^\circ\text{C}$

$V_T < 2 \text{ V}$

Rate of rise of off-state voltage that will not trigger any device; exponential method;

$V_D = 2/3 V_{DRMmax}; T_j = 125 \text{ }^\circ\text{C}$

$dV_D/dt < 200 \text{ V}/\mu\text{s}$

Reverse current

$V_R = V_{RWMmax}; T_j = 125 \text{ }^\circ\text{C}$

$I_R < 3 \text{ mA}$

Off-state current

$V_D = V_{DWMmax}; T_j = 125 \text{ }^\circ\text{C}$

$I_D < 3 \text{ mA}$

Latching current; $T_j = 25 \text{ }^\circ\text{C}$

$I_L < 150 \text{ mA}$

Holding current; $T_j = 25 \text{ }^\circ\text{C}$

$I_H < 75 \text{ mA}$

Gate to cathode

Voltage that will trigger all devices

$V_D = 6 \text{ V}; T_j = 25 \text{ }^\circ\text{C}$

$V_{GT} > 1.5 \text{ V}$

Voltage that will not trigger any device

$V_D = V_{DRMmax}; T_j = 125 \text{ }^\circ\text{C}$

$V_{GD} < 200 \text{ mV}$

Current that will trigger all devices

$V_D = 6 \text{ V}; T_j = 25 \text{ }^\circ\text{C}$

$I_{GT} > 30 \text{ mA}$

On request (see Ordering Note)

$I_{GT} > 20 \text{ mA}$

Switching characteristics

Gate-controlled turn-on time ($t_{gt} = t_d + t_r$) when switched from $V_D = V_{DRMmax}$ to $I_T = 40 \text{ A}$;

$I_{GT} = 100 \text{ mA}; dI_G/dt = 5 \text{ A}/\mu\text{s}; T_j = 25 \text{ }^\circ\text{C}$

$t_{gt} \text{ typ. } 2 \text{ } \mu\text{s}$

Circuit-commutated turn-off time when switched from $I_T = 40 \text{ A}$ to $V_R > 50 \text{ V}$ with

$-dI_T/dt = 10 \text{ A}/\mu\text{s}; dV_D/dt = 50 \text{ V}/\mu\text{s}; T_j = 115 \text{ }^\circ\text{C}$

$t_q \text{ typ. } 35 \text{ } \mu\text{s}$

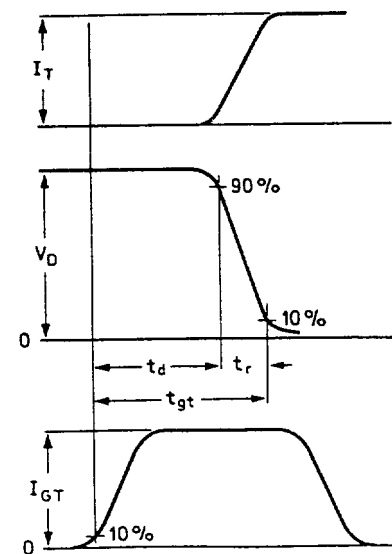

Fig. 2a Gate-controlled turn-on time definition.

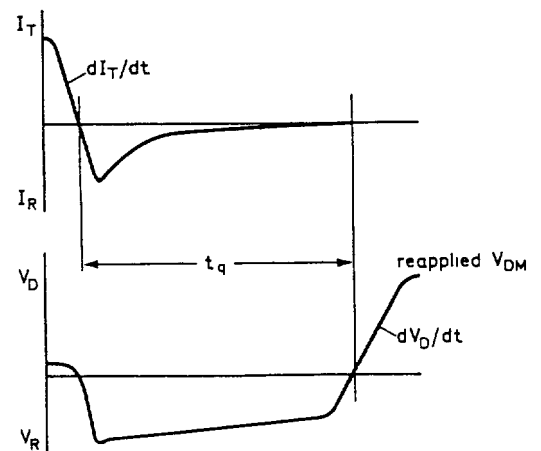

Fig. 2b Circuit-commutated turn-off time definition.

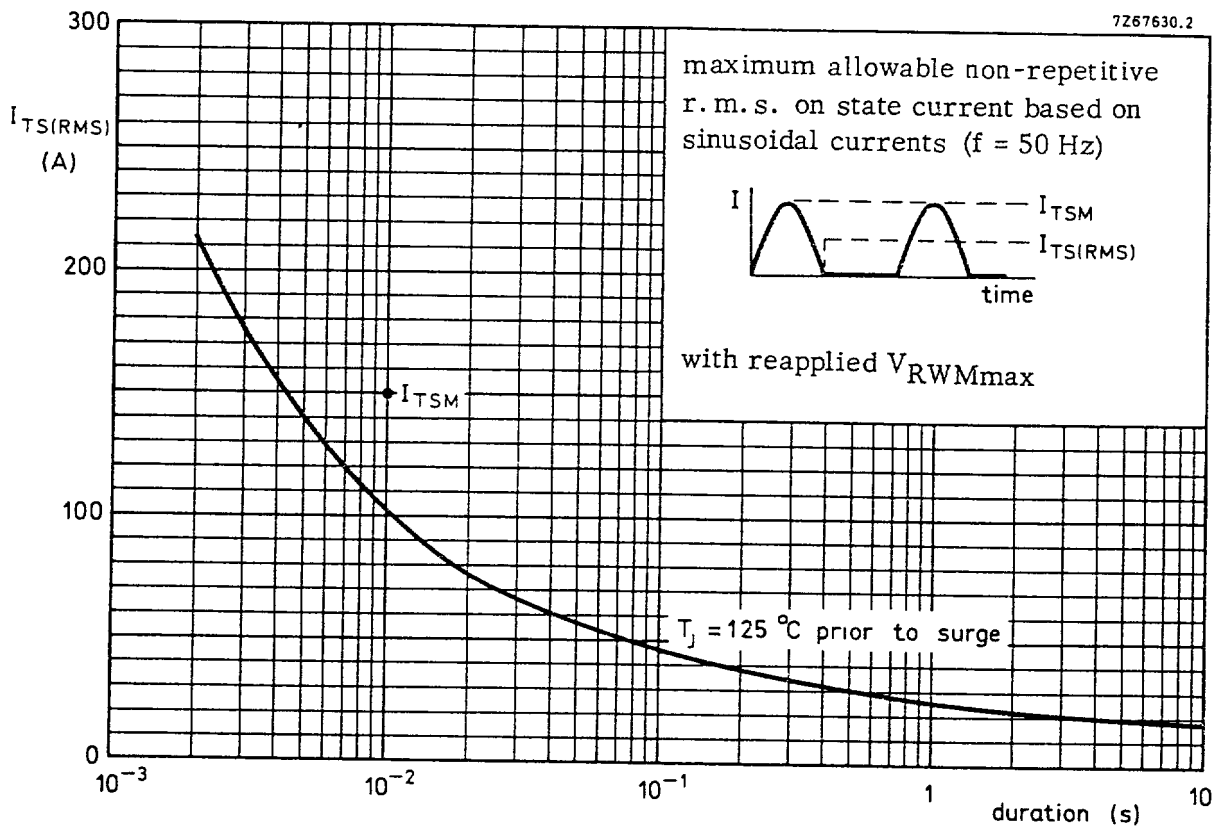

Fig. 4.

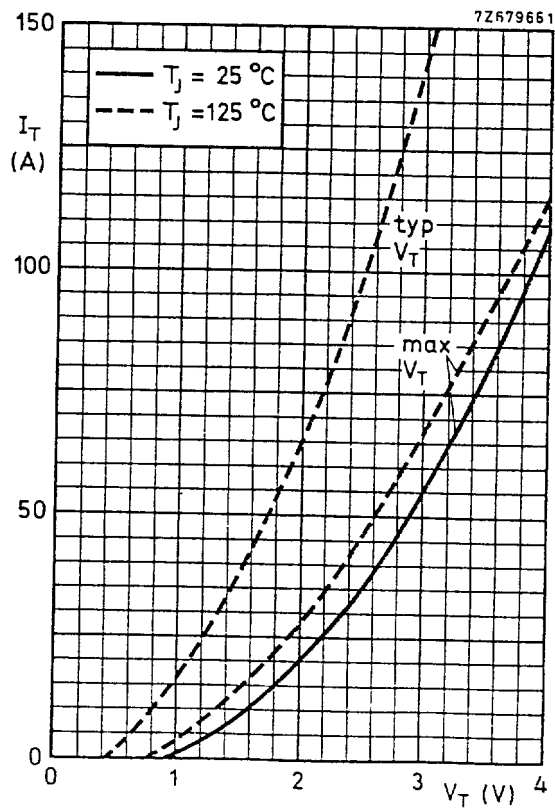

Fig. 5.

OPERATING NOTE

The terminals should neither be bent nor twisted; they should be soldered into the circuit so that there is no strain on them.
 During soldering the heat conduction to the junction should be kept to a minimum.

ORDERING NOTE

Types with low gate trigger current, $I_{GT} > 20$ mA, are available on request. Add suffix A to the type number when ordering: e.g. BTY79A-400R.

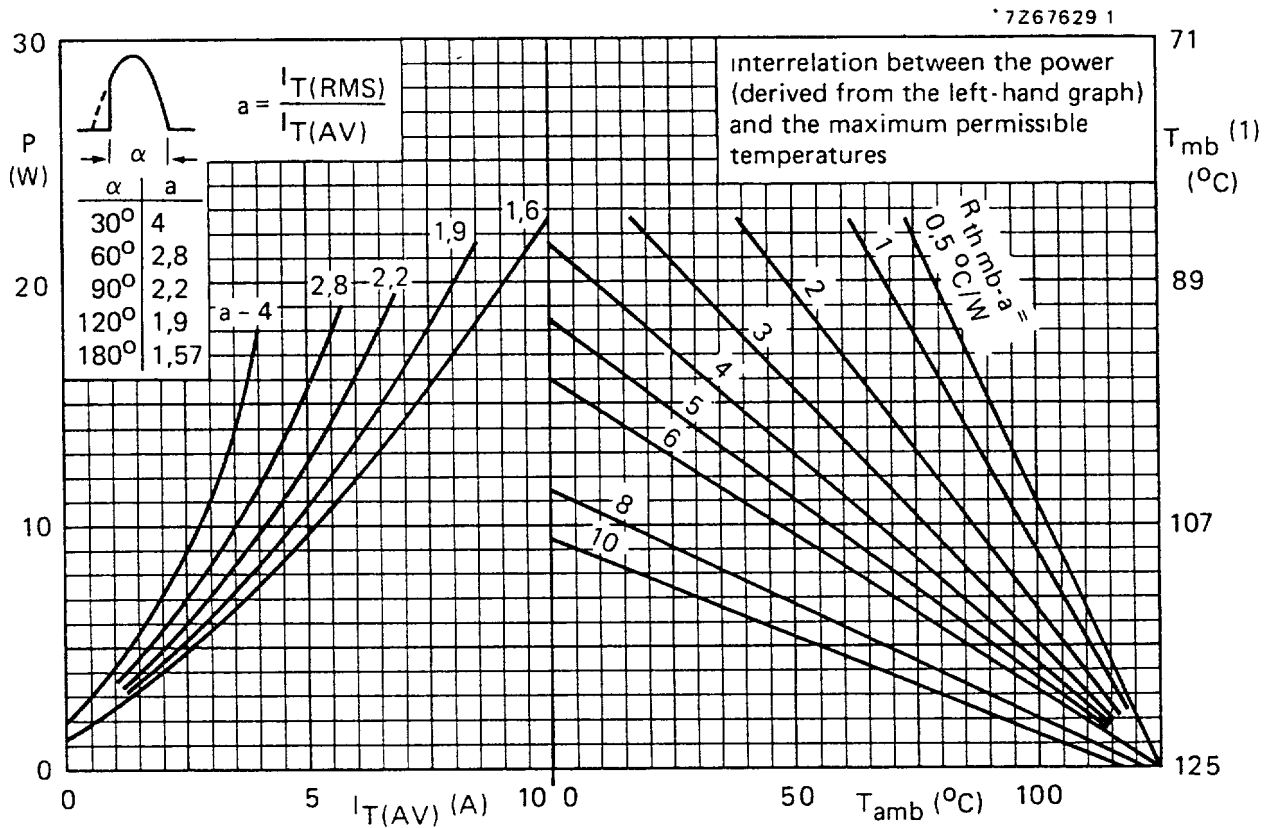

Fig. 3 (1) T_{mb} -scale is for comparison purposes only and is correct only for $R_{th\ mb-a} \leq 6\ ^\circ C/W$.

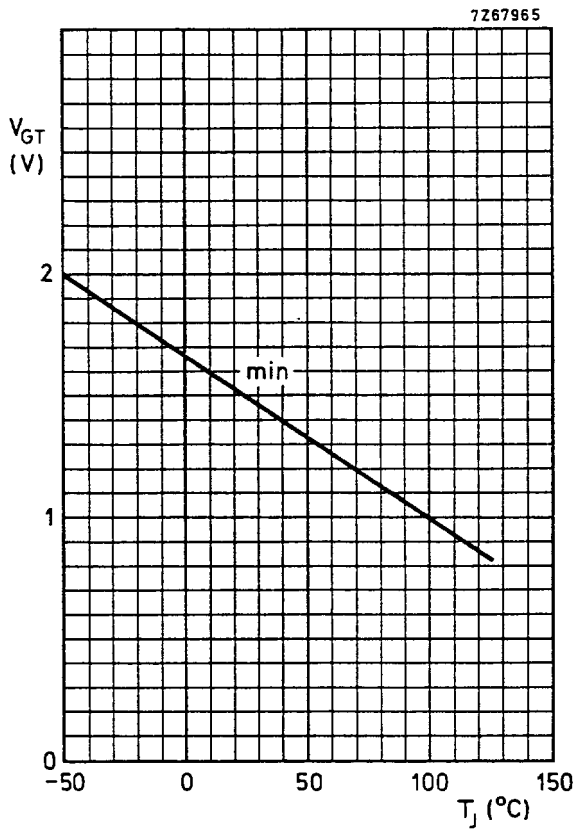

Fig. 6 Minimum gate voltage that will trigger all devices as a function of T_j .

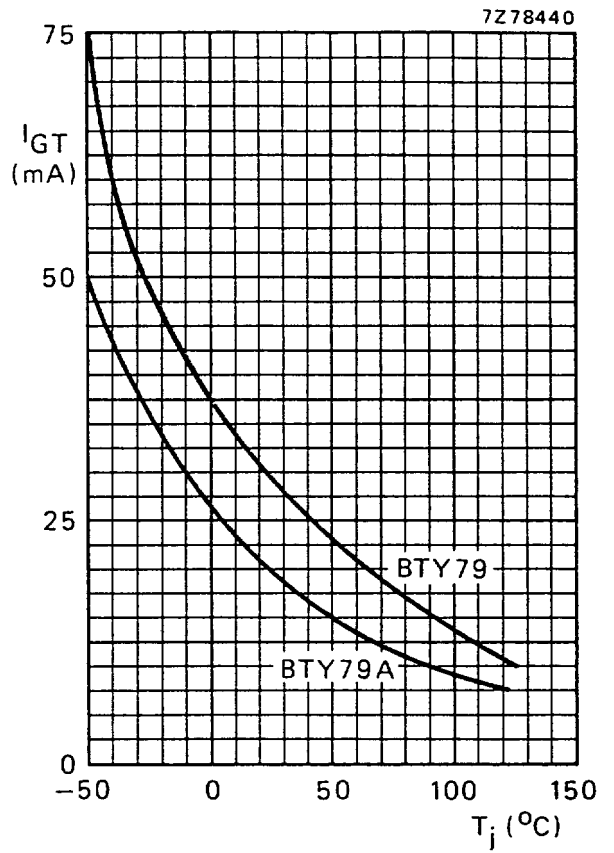

Fig. 7 Minimum gate current that will trigger all devices as a function of T_j .

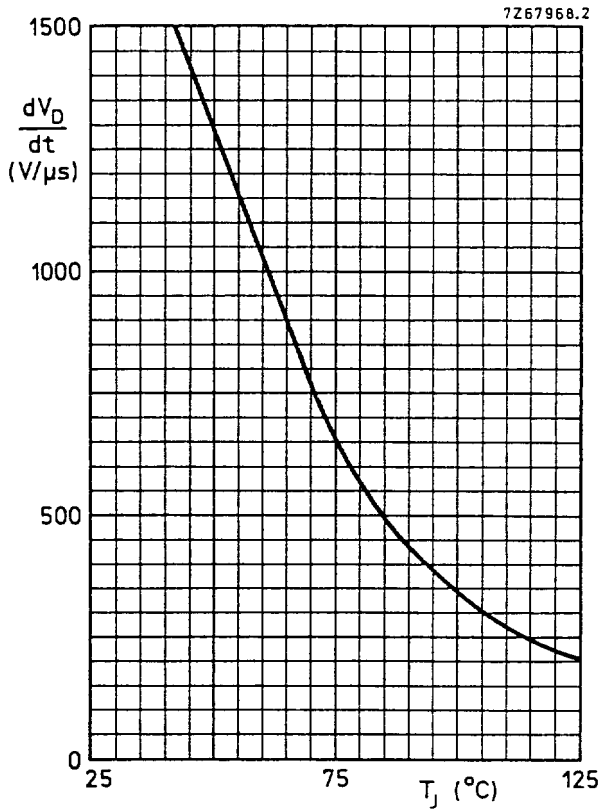

Fig. 8 Maximum rate of rise of off-state voltage that will not trigger any device (exponential method) as a function of T_J .

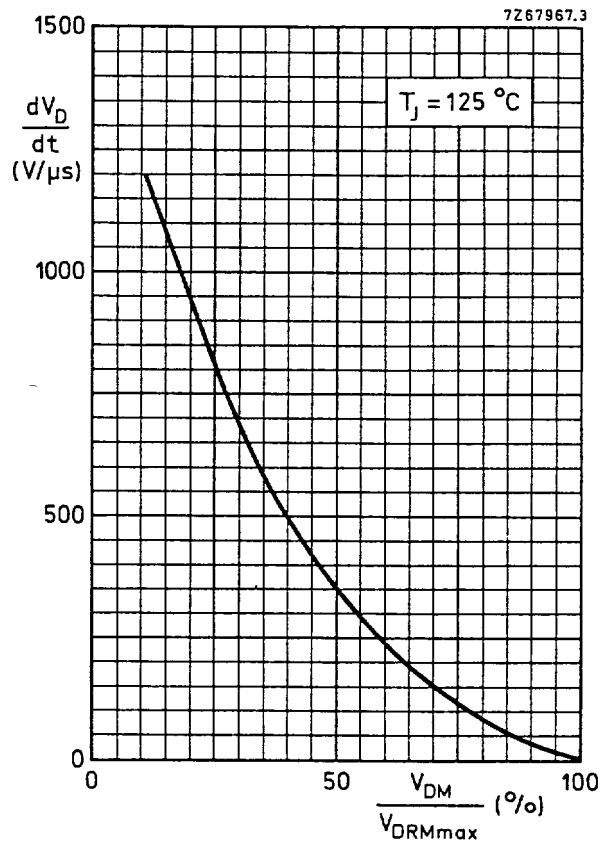

Fig. 9 Maximum rate of rise of off-state voltage that will not trigger any device (exponential method) as a function of applied voltage.

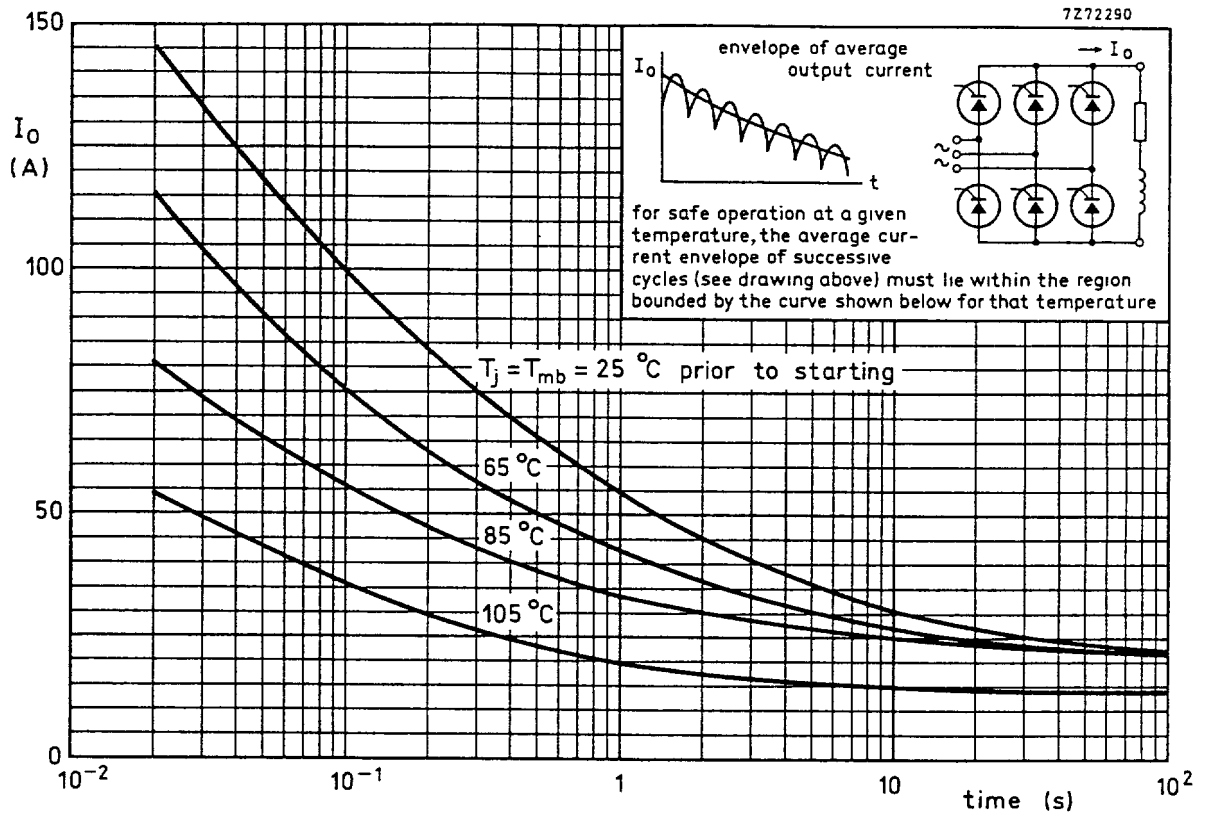

Fig. 11 Limits for starting or inrush currents.

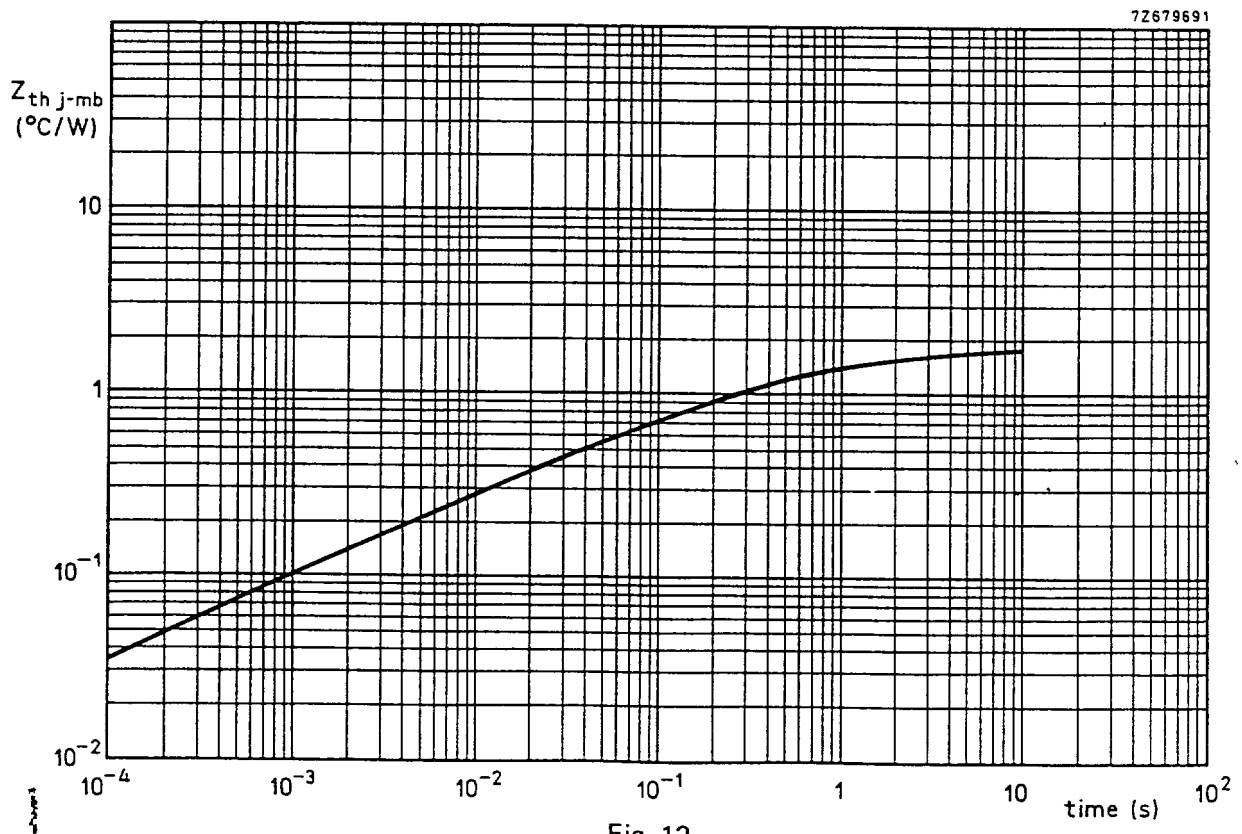

Fig. 12.

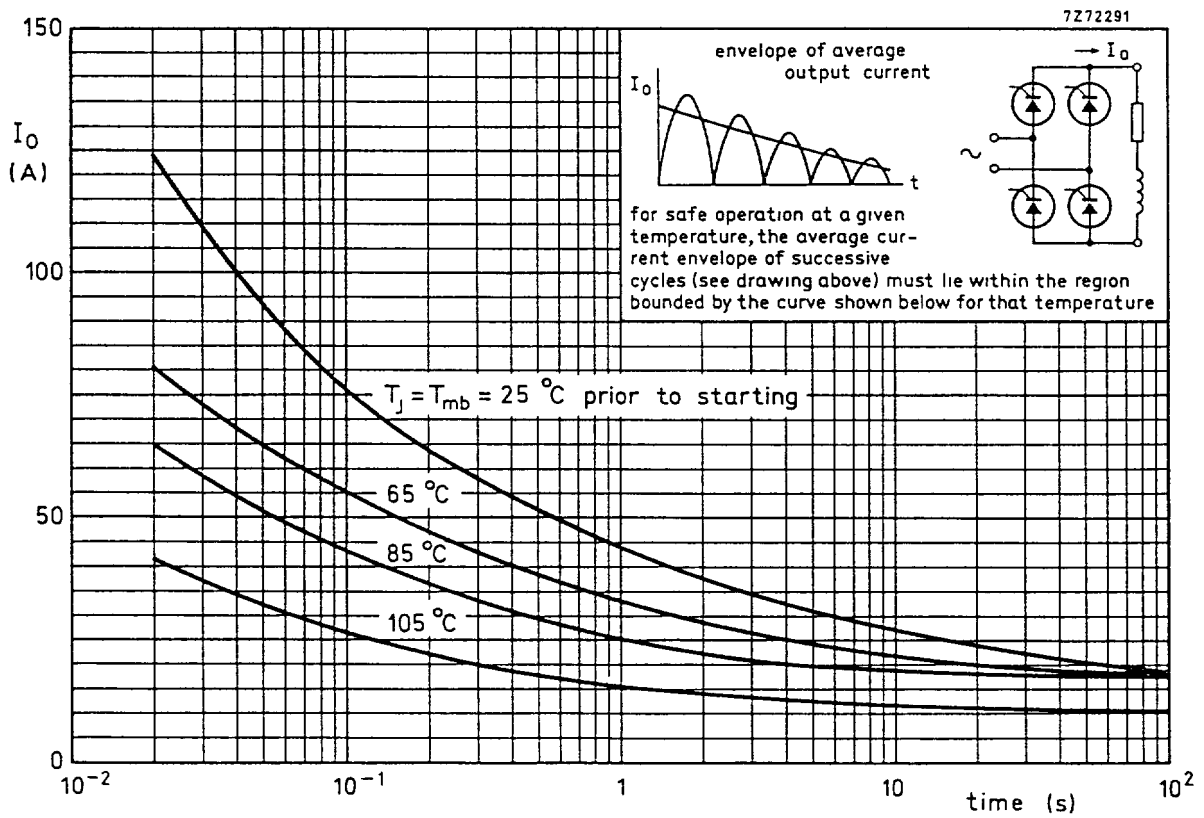
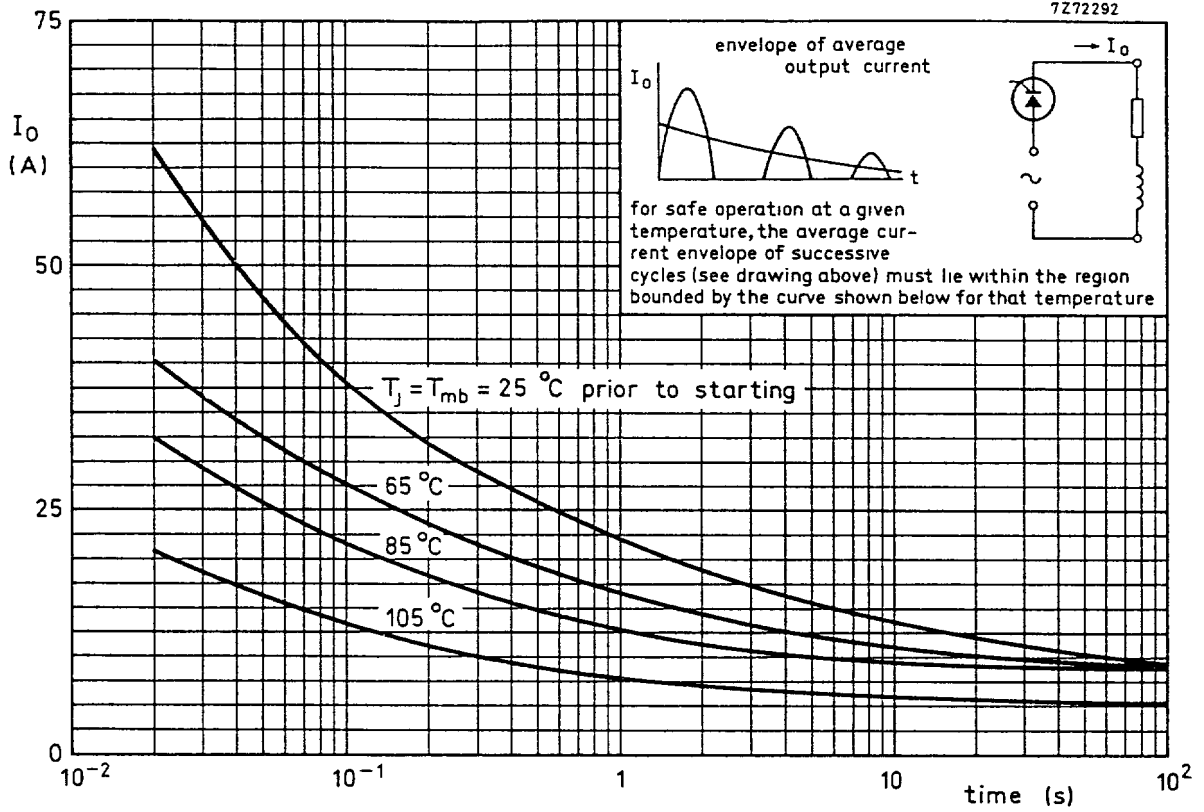

Fig. 10 Limits for starting or inrush currents.