

# AMMP-5620

## 6 – 20 GHz High Gain Amplifier in SMT Package

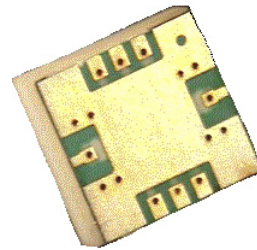

### Data Sheet



#### Description

The AMMP-5620 MMIC is a GaAs wide-band amplifier in a surface mount package designed for medium output power and high gain over the 6-20 GHz frequency range. The 3 cascaded stages provide high gain while the single bias supply offers ease of use. It is fabricated using a PHEMT integrated circuit process. The RF input and output ports have matching circuitry for use in 50-ohms environments. The MMIC is a cost effective alternative to hybrid (discrete FET) amplifiers that require complex tuning and assembly processes.

#### Pin Connections (Top View)

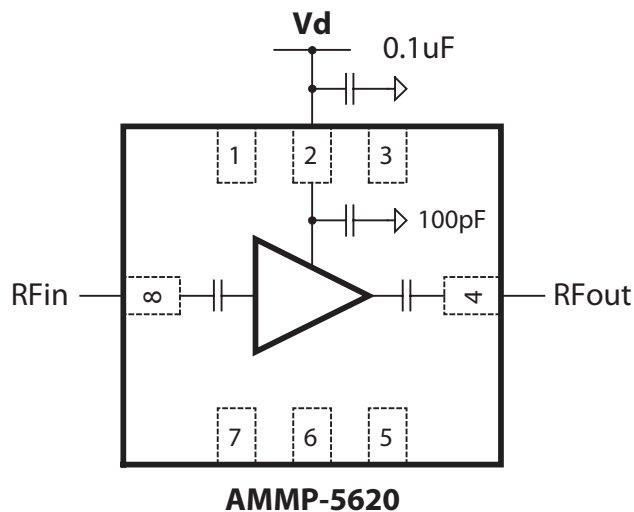

Note: Package base: GND

#### Features

- Surface Mount Package, 5.0 x 5.0 x 1.25 mm
- Wide Frequency Range 6-20 GHz
- High Gain: 17.5 dB Typical
- Medium Output P1dB: 14.8 dBm Typical
- Input and Output Return Loss: <-10 dB Typical
- 50 Ohm Input and Output Match
- Single Supply Bias: 5V @ 95 mA Typical

#### Applications

- General purpose, wide band amplifier in communication systems or microwave instrumentation
- High Gain Amplifier



**Attention:**  
**Observe precautions for handling electrostatic sensitive devices.**

**ESD Machine Model (= 40 V)**  
**ESD Human Body Model (= 150 V)**  
**Refer to Avago Application Note A004R: Electrostatic Discharge Damage and Control**

**Table 1. Absolute Maximum Ratings [1]**

Symbol	Parameters and Test Conditions	Unit	Minimum	Maximum
V <sub>dd</sub>	Positive Drain Voltage	V	-	7.5
I <sub>dd</sub>	Total Drain Current	mA	-	135
P <sub>dc</sub>	DC Power Dissipation	W	-	1.0
P <sub>in</sub>	RF CW Input Power	dBm	-	20
T <sub>ch</sub>	Operating Channel Temperature	°C	-	+150
T <sub>stg</sub>	Storage Case Temperature	°C	-65	+150
T <sub>max</sub>	Maximum Assembly Temperature (20 sec max)	°C	-	+260

Notes:

1. Operation in excess of any one of these conditions may result in permanent damage to this device.  
The absolute maximum ratings for V<sub>dd</sub>, I<sub>dd</sub>, P<sub>dc</sub> and P<sub>in</sub> were determined at an ambient temperature of 25°C unless noted otherwise.

**Table 2. DC Specifications [1]**

Symbol	Parameters and Test Conditions	Unit	Minimum	Typical	Maximum
V <sub>dd</sub>	Recommended Drain Supply Voltage	V	-	5	-
I <sub>dd</sub>	Total Drain Supply Current	mA	70	95	130
θ <sub>ch-b</sub>	Thermal Resistance [2]	°C/W	-	28	-

Notes:

1. Ambient operation temperature T<sub>A</sub> = 25°C unless otherwise noted.
2. Channel-to-board Thermal Resistance is measured using Infrared Microscopy method.

**Table 3. RF Specifications [2,3] (T<sub>A</sub> = 25°C, Freq = 18GHz, V<sub>dd</sub> = 5V, I<sub>dd</sub> = 95mA)**

Symbol	Parameters and Test Conditions	Unit	Minimum	Typical	Maximum
S <sub>21</sub>   <sup>2</sup>	Small signal Gain [1,4]	dB	15.5	17.5	19.5
RL <sub>in</sub>	Input Return Loss	dB	-	11.5	-
RL <sub>out</sub>	Output Return Loss	dB	-	11.6	-
S <sub>12</sub>   <sup>2</sup>	Reverse Isolation	dB	-	-43.0	-
P1dB	Output Power at 1dB Gain Compression	dBm	-	14.8	-
OIP3	Output 3rd Order Intercept Point	dBm	-	22.5	-
NF	Noise Figure [1,4]	dB	-	5.1	7.0

Notes:

1. Typical value determined from a sample size of 500 parts from 2 wafers.
2. Small/large signal data measured in a fully de-embedded test fixture at T<sub>A</sub> = 25 degree Celsius.
3. Specifications are derived from measurements in a 50 Ohm test environment. Aspects of the amplifier performance may be improved over a narrower bandwidth by application of additional conjugate, linearity, or low noise matching.
4. All tested parameters guaranteed with measurement accuracy ± 0.5 dB for NF and ± 1.0 dB for gain.

**AMMP-5620 Typical Performance vs. Frequency ( $T_A = 25^\circ\text{C}$ ,  $V_{dd} = 5\text{V}$ ,  $I_{dd} = 95\text{mA}$ ,  $Z_{in} = Z_o = 50\Omega$ )**

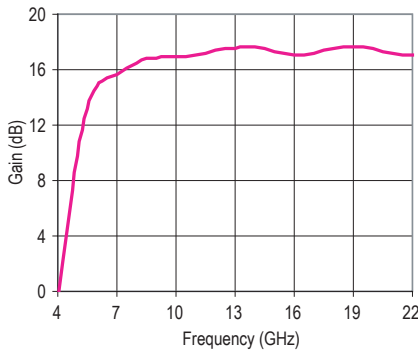

**Figure 1. Gain**

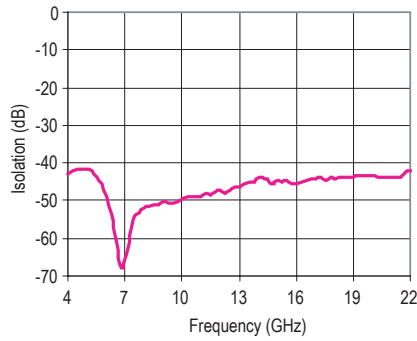

**Figure 2. Isolation**

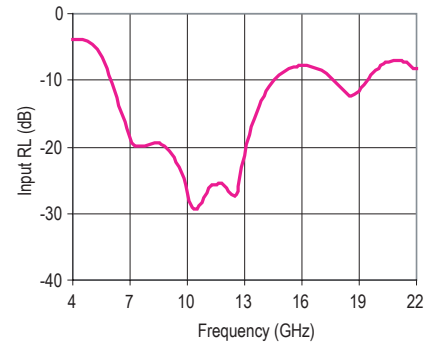

**Figure 3. Input Return Loss**

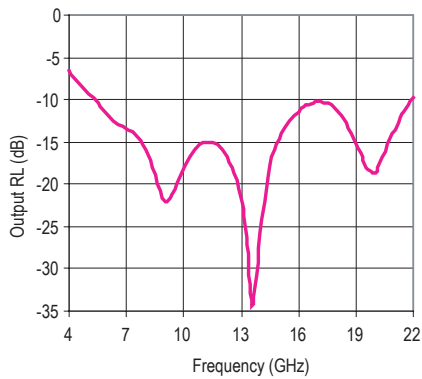

**Figure 4. Output Return Loss**

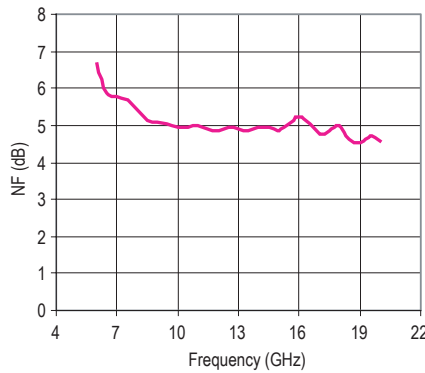

**Figure 5. Noise Figure**

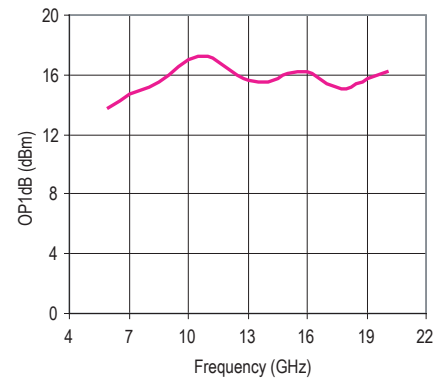

**Figure 6. P1dB**

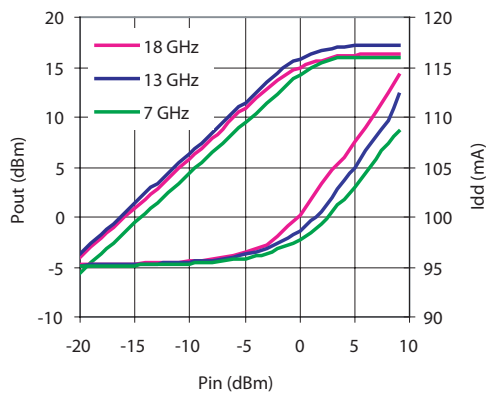

**Figure 7. Pout and Idd vs. Pin**

Note: These measurements are obtained using demo board with 50 Ohm traces at input and output. Aspects of the amplifier performance may be improved over a narrower bandwidth by application of additional conjugate, linearity or low noise matching.

**AMMP-5620 Typical Performance vs. Supply Voltage ( $T_A = 25^\circ\text{C}$ ,  $Z_{in} = Z_o = 50\Omega$ )**

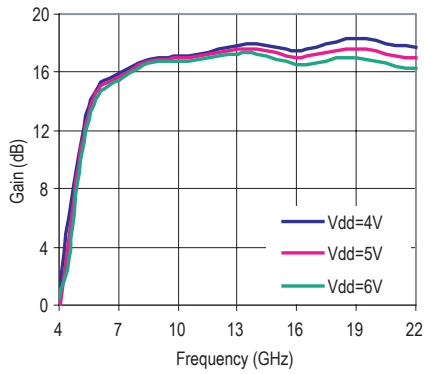

**Figure 8. Gain and Voltage**

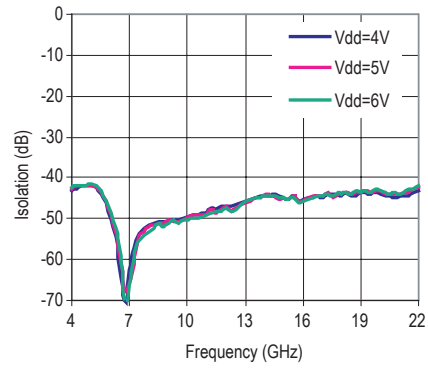

**Figure 9. Isolation and Voltage**

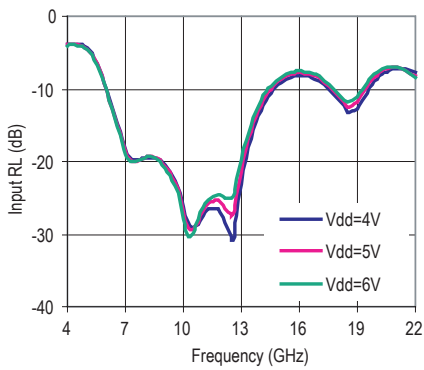

**Figure 10. Input Return Loss and Voltage**

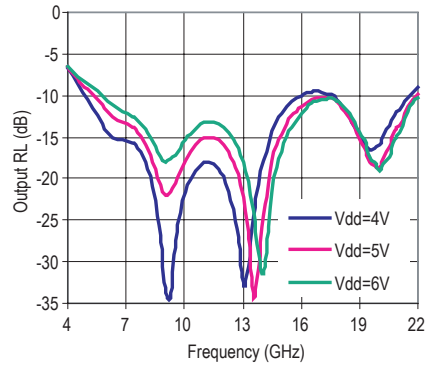

**Figure 11. Output Return Loss and Voltage**

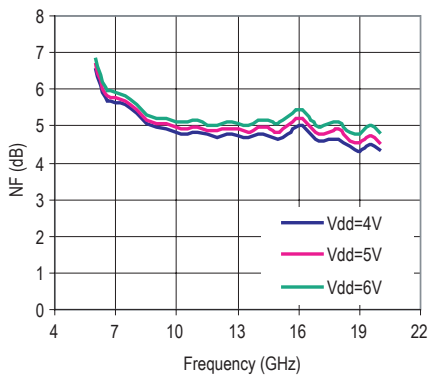

**Figure 12. Noise Figure and Voltage**

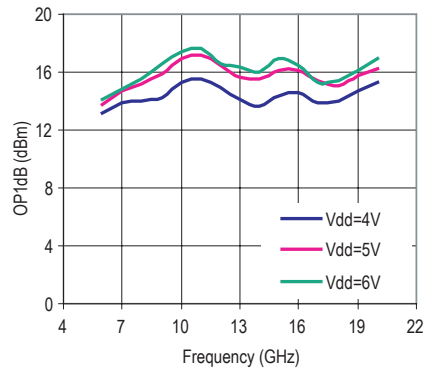

**Figure 13. P1dB and Voltage**

Note: These measurements are obtained using demo board with 50 Ohm traces at input and output. Aspects of the amplifier performance may be improved over a narrower bandwidth by application of additional conjugate, linearity or low noise matching.

## AMMP-5620 Typical Performance vs. Temperature (Vdd = 5V, Zin = Zo = 50Ω)

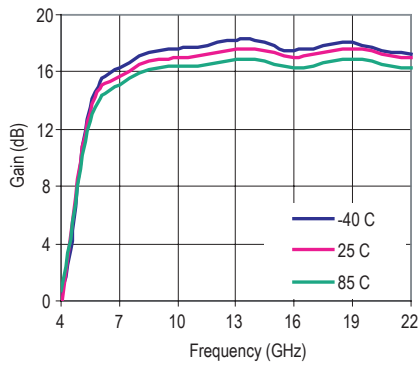

Figure 14. Gain and Temperature

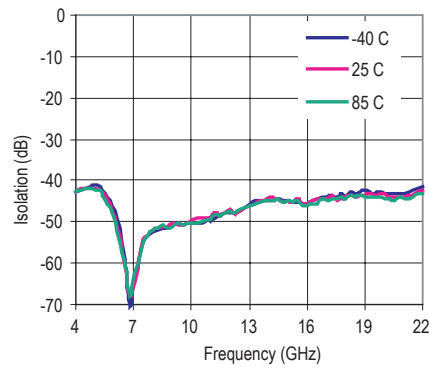

Figure 15. Isolation and Temperature

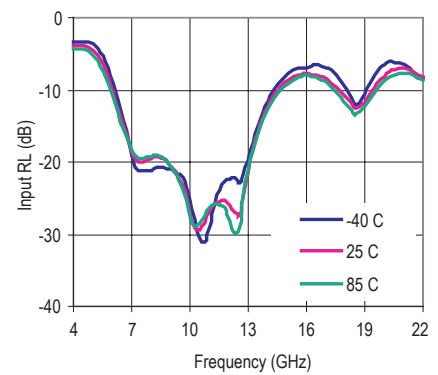

Figure 16. Input Return Loss and Temperature

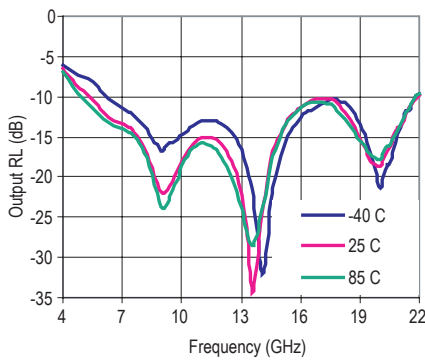

Figure 17. Output Return Loss and Temperature

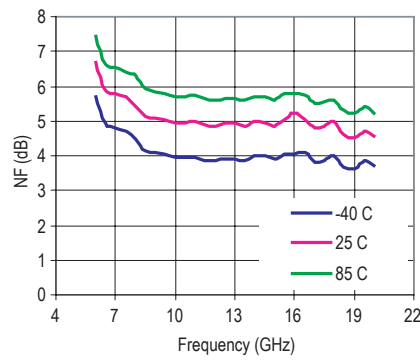

Figure 18. Noise Figure and Temperature

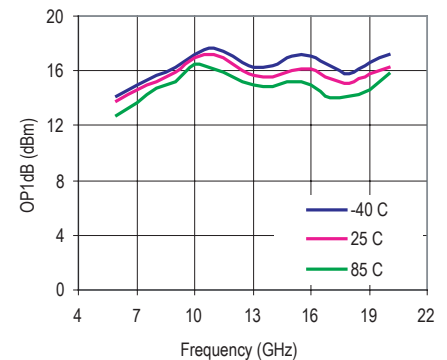

Figure 19. P1dB and Temperature

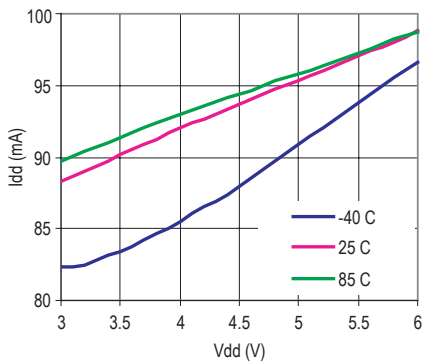

Figure 20. Idd vs. Vdd

Note: These measurements are obtained using demo board with 50 Ohm traces at input and output. Aspects of the amplifier performance may be improved over a narrower bandwidth by application of additional conjugate, linearity or low noise matching.

**AMMP-5620 Typical Scattering Parameters ( $T_A = 25^\circ\text{C}$ ,  $V_{dd} = 4\text{V}$ ,  $I_{dd} = 92\text{mA}$ ,  $Z_0 = 50\Omega$ )**

Frea GHz	S11			S21			S12			S22		
	dB	Mag	Phase	dB	Mag	Phase	dB	Mag	Phase	dB	Mag	Phase
2.00	-3.392	0.677	53.71	-22.616	0.074	64.56	-47.331	0.004	-43.40	-1.731	0.819	131.99
2.50	-3.821	0.644	-9.44	-16.131	0.156	-9.57	-45.680	0.005	-126.00	-2.767	0.727	77.32
3.00	-4.034	0.629	-73.08	-10.218	0.308	-76.02	-44.583	0.006	147.93	-4.038	0.628	25.10
3.50	-4.037	0.628	-136.32	-4.886	0.570	-136.04	-44.013	0.006	56.21	-5.274	0.545	-28.02
4.00	-3.883	0.640	162.19	0.492	1.058	166.25	-43.223	0.007	-31.89	-6.640	0.466	-88.45
4.50	-3.799	0.646	102.28	5.728	1.934	105.77	-42.158	0.008	-116.60	-8.443	0.378	-161.20
5.00	-4.301	0.610	41.50	10.597	3.387	39.41	-42.047	0.008	162.33	-10.385	0.303	116.30
5.50	-6.217	0.489	-19.26	13.987	5.004	-34.08	-43.876	0.006	90.43	-12.242	0.244	39.65
6.00	-9.881	0.321	-73.25	15.547	5.989	-106.30	-49.630	0.003	19.94	-14.244	0.194	-14.96
6.50	-14.370	0.191	-113.37	16.018	6.323	-171.85	-61.938	0.001	-28.72	-15.199	0.174	-52.05
7.00	-18.027	0.126	-139.47	16.297	6.529	129.56	-60.915	0.001	60.78	-15.411	0.170	-85.59
7.50	-19.794	0.102	-160.36	16.684	6.827	74.54	-53.979	0.002	32.98	-15.826	0.162	-122.02
8.00	-19.593	0.105	170.89	17.170	7.219	19.92	-51.701	0.003	-12.09	-17.735	0.130	-162.68
8.50	-19.461	0.106	130.27	17.430	7.439	-33.97	-50.752	0.003	-49.75	-22.114	0.078	152.70
9.00	-20.455	0.095	84.36	17.536	7.530	-86.25	-50.752	0.003	-83.81	-32.324	0.024	96.16
9.50	-22.361	0.076	34.60	17.575	7.564	-136.97	-50.173	0.003	-118.89	-28.134	0.039	-70.69
10.00	-25.900	0.051	-26.77	17.641	7.622	173.56	-49.370	0.003	-149.20	-21.927	0.080	-118.97
10.50	-28.947	0.036	-109.35	17.694	7.668	124.81	-48.874	0.004	178.49	-19.236	0.109	-157.79
11.00	-27.535	0.042	167.11	17.784	7.749	76.68	-48.636	0.004	142.57	-18.146	0.124	164.93
11.50	-26.430	0.048	103.17	17.978	7.924	29.02	-47.744	0.004	113.01	-18.244	0.122	127.03
12.00	-27.432	0.043	47.93	18.185	8.114	-18.34	-46.936	0.005	78.56	-19.576	0.105	87.45
12.50	-30.722	0.029	-46.78	18.275	8.199	-66.32	-46.558	0.005	47.55	-23.440	0.067	45.23
13.00	-23.702	0.065	-149.09	18.489	8.403	-114.29	-45.514	0.005	10.59	-31.768	0.026	-33.28
13.50	-17.115	0.139	157.09	18.693	8.603	-162.54	-44.883	0.006	-28.75	-25.067	0.056	-170.66
14.00	-13.132	0.221	114.54	18.841	8.751	149.01	-44.293	0.006	-64.72	-18.223	0.123	139.13
14.50	-10.686	0.292	75.62	18.570	8.482	100.90	-44.152	0.006	-101.95	-14.535	0.188	99.29
15.00	-9.229	0.346	38.70	18.197	8.126	54.29	-45.036	0.006	-139.33	-12.274	0.243	62.73
15.50	-8.382	0.381	2.16	18.245	8.170	9.19	-44.583	0.006	-175.53	-10.776	0.289	28.24
16.00	-8.197	0.389	-34.39	18.109	8.044	-34.26	-45.352	0.005	158.27	-10.114	0.312	-5.12
16.50	-8.291	0.385	-70.91	18.239	8.164	-79.87	-44.883	0.006	123.49	-9.646	0.329	-38.26
17.00	-8.855	0.361	-108.85	18.433	8.349	-127.21	-44.731	0.006	85.22	-9.549	0.333	-72.46
17.50	-9.949	0.318	-150.10	18.445	8.360	-172.86	-44.152	0.006	54.36	-9.870	0.321	-107.43
18.00	-11.496	0.266	162.22	18.647	8.558	139.62	-44.437	0.006	15.26	-10.885	0.286	-145.36
18.50	-13.104	0.221	103.16	18.818	8.727	93.41	-44.293	0.006	-15.94	-12.483	0.238	173.22
19.00	-12.765	0.230	36.19	19.126	9.043	43.83	-43.742	0.007	-52.34	-14.813	0.182	123.98
19.50	-10.701	0.292	-23.30	19.268	9.192	-5.97	-43.876	0.006	-86.50	-16.444	0.151	62.33
20.00	-8.835	0.362	-70.75	19.077	8.992	-55.35	-44.013	0.006	-120.15	-15.901	0.160	1.77
20.50	-7.677	0.413	-111.70	18.685	8.595	-104.03	-44.437	0.006	-154.67	-13.744	0.206	-47.46
21.00	-7.218	0.436	-150.98	18.366	8.285	-150.44	-44.583	0.006	175.09	-11.890	0.254	-85.98
21.50	-7.190	0.437	168.74	18.081	8.018	162.58	-44.437	0.006	150.09	-10.354	0.304	-121.21
22.00	-7.614	0.416	124.80	18.370	8.289	115.35	-43.350	0.007	119.82	-9.077	0.352	-157.12
22.50	-8.050	0.396	73.12	18.942	8.854	67.61	-41.110	0.009	84.67	-8.148	0.391	164.79
23.00	-7.490	0.422	7.61	19.537	9.481	17.62	-39.016	0.011	35.70	-7.802	0.407	121.56
23.50	-6.164	0.492	-80.14	19.515	9.457	-42.37	-40.537	0.009	-27.89	-8.752	0.365	81.87
24.00	-5.293	0.544	-161.93	18.527	8.440	-104.37	-45.514	0.005	-68.17	-8.847	0.361	48.30
24.50	-4.602	0.589	129.44	17.199	7.243	-161.50	-49.630	0.003	-81.81	-8.802	0.363	11.43
25.00	-4.247	0.613	70.63	15.285	5.811	146.41	-49.897	0.003	-93.56	-8.828	0.362	-26.36

Note: S-parameters are obtained using demo board with 50 Ohm traces at input and output.

**AMMP-5620 Typical Scattering Parameters ( $T_A = 25^\circ\text{C}$ ,  $V_{dd} = 5\text{V}$ ,  $I_{dd} = 95\text{mA}$ ,  $Z_0 = 50\Omega$ )**

Freq GHz	S11			S21			S12			S22		
	dB	Mag	Phase	dB	Mag	Phase	dB	Mag	Phase	dB	Mag	Phase
2.00	-3.407	0.676	53.67	-23.012	0.071	64.54	-47.535	0.004	-46.84	-1.719	0.820	131.87
2.50	-3.838	0.643	-9.56	-16.623	0.148	-9.82	-45.680	0.005	-127.29	-2.711	0.732	76.91
3.00	-4.066	0.626	-73.27	-10.798	0.288	-76.79	-44.883	0.006	147.52	-3.953	0.634	23.89
3.50	-4.085	0.625	-136.57	-5.550	0.528	-137.32	-43.609	0.007	59.64	-5.188	0.550	-30.29
4.00	-3.957	0.634	161.91	-0.284	0.968	164.88	-42.853	0.007	-29.81	-6.479	0.474	-91.93
4.50	-3.908	0.638	102.02	4.862	1.750	104.89	-41.724	0.008	-115.15	-7.935	0.401	-165.83
5.00	-4.423	0.601	41.50	9.760	3.076	39.54	-41.724	0.008	165.10	-9.211	0.346	112.05
5.50	-6.310	0.484	-19.18	13.283	4.615	-33.23	-43.479	0.007	91.89	-10.354	0.304	36.78
6.00	-9.984	0.317	-73.52	14.987	5.615	-105.50	-48.404	0.004	18.63	-11.849	0.256	-19.81
6.50	-14.624	0.186	-113.60	15.547	5.989	-171.58	-59.172	0.001	-41.02	-12.872	0.227	-61.58
7.00	-18.395	0.120	-138.23	15.908	6.243	129.38	-64.437	0.001	66.84	-13.453	0.213	-98.68
7.50	-19.931	0.101	-158.07	16.387	6.597	74.06	-54.425	0.002	32.17	-14.071	0.198	-138.00
8.00	-19.576	0.105	172.38	16.956	7.043	18.71	-52.041	0.003	-13.20	-15.682	0.164	176.27
8.50	-19.453	0.107	130.69	17.261	7.295	-36.19	-51.057	0.003	-48.69	-18.592	0.118	120.56
9.00	-20.565	0.094	83.97	17.386	7.401	-89.26	-50.458	0.003	-84.50	-21.884	0.081	49.32
9.50	-22.698	0.073	32.87	17.394	7.408	-140.66	-50.752	0.003	-114.52	-20.640	0.093	-34.05
10.00	-26.651	0.047	-31.69	17.420	7.430	169.24	-49.370	0.003	-149.09	-17.931	0.127	-91.80
10.50	-29.396	0.034	-122.59	17.431	7.440	119.81	-49.119	0.004	179.06	-16.060	0.157	-138.08
11.00	-27.013	0.045	153.65	17.470	7.473	71.18	-48.874	0.004	145.67	-15.114	0.176	-179.35
11.50	-25.613	0.052	90.79	17.612	7.597	23.17	-48.636	0.004	112.76	-15.021	0.177	140.77
12.00	-26.021	0.050	32.22	17.791	7.755	-24.60	-47.131	0.004	80.42	-15.756	0.163	101.16
12.50	-27.171	0.044	-56.40	17.838	7.796	-73.06	-47.535	0.004	48.72	-17.835	0.128	62.47
13.00	-21.724	0.082	-145.03	17.996	7.940	-121.36	-46.196	0.005	12.23	-21.745	0.082	19.12
13.50	-16.088	0.157	159.43	18.133	8.066	-169.78	-45.036	0.006	-27.17	-32.616	0.023	-58.58
14.00	-12.432	0.239	115.43	18.204	8.132	141.80	-44.152	0.006	-61.69	-24.898	0.057	155.40
14.50	-10.117	0.312	75.65	17.909	7.860	93.60	-44.437	0.006	-101.48	-18.216	0.123	109.09
15.00	-8.749	0.365	38.09	17.492	7.492	46.59	-44.883	0.006	-137.21	-14.765	0.183	72.08
15.50	-7.954	0.400	0.98	17.443	7.450	1.09	-44.583	0.006	-171.56	-12.560	0.236	37.77
16.00	-7.789	0.408	-36.04	17.188	7.235	-42.76	-45.680	0.005	158.96	-11.415	0.269	5.30
16.50	-7.907	0.402	-73.32	17.217	7.259	-88.02	-44.583	0.006	126.85	-10.580	0.296	-27.45
17.00	-8.475	0.377	-112.22	17.395	7.409	-135.20	-44.293	0.006	92.92	-10.215	0.309	-61.15
17.50	-9.559	0.333	-154.89	17.333	7.356	179.22	-44.583	0.006	56.05	-10.303	0.305	-95.10
18.00	-11.044	0.280	155.57	17.493	7.493	131.68	-44.152	0.006	21.24	-11.128	0.278	-130.85
18.50	-12.356	0.241	94.68	17.516	7.512	85.39	-43.876	0.006	-10.75	-12.616	0.234	-168.75
19.00	-11.768	0.258	28.44	17.752	7.719	36.44	-43.609	0.007	-48.52	-15.055	0.177	148.38
19.50	-9.832	0.322	-29.47	17.897	7.849	-12.86	-43.479	0.007	-82.80	-17.897	0.127	92.99
20.00	-8.223	0.388	-76.66	17.687	7.663	-61.51	-43.350	0.007	-114.34	-18.644	0.117	28.34
20.50	-7.323	0.430	-117.90	17.321	7.346	-109.66	-44.013	0.006	-149.87	-16.205	0.155	-29.59
21.00	-7.103	0.441	-157.70	16.972	7.057	-155.84	-44.013	0.006	-179.43	-13.601	0.209	-72.00
21.50	-7.351	0.429	161.32	16.689	6.831	157.50	-43.742	0.007	149.78	-11.483	0.267	-109.23
22.00	-8.112	0.393	116.27	16.962	7.048	110.49	-42.270	0.008	117.97	-9.911	0.320	-146.85
22.50	-8.920	0.358	62.93	11.755	7.493	62.42	-40.630	0.009	78.99	-8.913	0.358	174.20
23.00	-8.688	0.368	-4.82	17.900	7.852	12.29	-39.332	0.011	28.16	-8.709	0.367	131.96
23.50	-7.331	0.430	-91.21	17.558	7.549	-45.62	-41.618	0.008	-33.37	-9.335	0.341	95.47
24.00	-6.166	0.492	-168.93	16.641	6.793	-104.51	-46.936	0.005	-69.14	-8.981	0.356	61.41
24.50	-5.232	0.548	125.79	15.583	6.014	-159.57	-50.752	0.003	-80.08	-8.742	0.366	24.42
25.00	-4.687	0.583	68.92	13.967	4.993	149.42	-50.173	0.003	-80.98	-8.547	0.374	-13.10

Note: S-parameters are obtained using demo board with 50 Ohm traces at input and output.

**AMMP-5620 Typical Scattering Parameters ( $T_A = 25^\circ\text{C}$ ,  $V_{dd} = 6\text{V}$ ,  $I_{dd} = 99\text{mA}$ ,  $Z_0 = 50\Omega$ )**

Freq GHz	S11			S21			S12			S22		
	dB	Mag	Phase	dB	Mag	Phase	dB	Mag	Phase	dB	Mag	Phase
2.00	-3.416	0.675	53.66	-23.295	0.068	64.59	-47.131	0.004	-44.87	-1.710	0.821	131.81
2.50	-3.851	0.642	-9.62	-17.047	0.140	-10.40	-45.849	0.005	-125.03	-2.675	0.735	76.65
3.00	-4.094	0.624	-73.39	-11.275	0.273	-77.86	-44.731	0.006	150.46	-3.894	0.639	23.09
3.50	-4.126	0.622	-136.79	-6.106	0.495	-138.83	-44.152	0.006	59.41	-5.119	0.555	-31.79
4.00	-4.016	0.630	161.59	-0.927	0.899	163.06	-42.615	0.007	-28.22	-6.355	0.481	-94.22
4.50	-3.999	0.631	101.74	4.127	1.608	103.24	-41.724	0.008	-113.46	-7.614	0.416	-168.71
5.00	-4.535	0.593	41.39	9.012	2.822	38.51	-41.412	0.009	165.26	-8.536	0.374	109.84
5.50	-6.419	0.478	-19.13	12.588	4.260	-33.69	-43.098	0.007	92.29	-9.332	0.342	35.77
6.00	-10.097	0.313	-73.67	14.381	5.237	-105.87	-47.959	0.004	21.78	-10.536	0.297	-21.31
6.50	-14.827	0.181	-113.73	15.013	5.632	-172.25	-57.721	0.001	-35.16	-11.483	0.267	-65.12
7.00	-18.688	0.116	-137.28	15.433	5.911	128.40	-64.437	0.001	42.77	-12.111	0.248	-104.28
7.50	-20.044	0.100	-156.35	15.981	6.295	72.88	-55.391	0.002	34.32	-12.732	0.231	-145.31
8.00	-19.601	0.105	173.55	16.608	6.767	16.96	-53.152	0.002	-14.23	-14.032	0.199	167.20
8.50	-19.510	0.106	131.02	16.943	7.033	-38.71	-51.373	0.003	-48.50	-16.060	0.157	110.46
9.00	-20.762	0.092	83.56	17.083	7.147	-92.36	-51.057	0.003	-87.09	-17.924	0.127	44.58
9.50	-23.173	0.069	31.58	17.068	7.135	-144.29	-51.057	0.003	-118.15	-17.228	0.138	-26.23
10.00	-27.660	0.041	-36.67	17.060	7.129	165.08	-50.458	0.003	-151.04	-15.509	0.168	-82.70
10.50	-29.843	0.032	-136.34	17.035	7.108	115.14	-49.897	0.003	179.35	-14.089	0.198	-130.16
11.00	-26.521	0.047	141.48	17.029	7.103	66.07	-49.119	0.004	147.01	-13.287	0.217	-172.78
11.50	-24.867	0.057	80.58	17.137	7.192	17.81	-48.404	0.004	116.50	-13.167	0.220	146.51
12.00	-24.852	0.057	20.29	17.281	7.313	-30.36	-47.535	0.004	80.62	-13.689	0.207	106.47
12.50	-24.867	0.057	-63.84	17.287	7.317	-79.21	-47.744	0.004	51.23	-15.154	0.175	67.50
13.00	-20.131	0.099	-144.42	17.399	7.412	-127.72	-45.849	0.005	15.67	-17.768	0.129	25.89
13.50	-15.179	0.174	159.95	17.480	7.482	-176.25	-45.036	0.006	-21.21	-23.388	0.068	-21.43
14.00	-11.822	0.256	115.28	17.483	7.484	135.39	-44.583	0.006	-64.33	-31.150	0.028	-141.86
14.50	-9.672	0.328	74.94	17.173	7.222	87.09	-44.583	0.006	-98.24	-21.971	0.080	126.31
15.00	-8.379	0.381	37.04	16.722	6.857	39.86	-44.883	0.006	-135.72	-16.887	0.143	83.97
15.50	-7.641	0.415	-0.43	16.599	6.760	-5.93	-44.883	0.006	-170.92	-13.897	0.202	48.18
16.00	-7.504	0.422	-37.75	16.261	6.502	-50.07	-45.514	0.005	160.43	-12.238	0.244	15.40
16.50	-7.656	0.414	-75.55	16.216	6.468	-95.08	-44.731	0.006	129.01	-11.032	0.281	-17.95
17.00	-8.239	0.387	-115.08	16.385	6.596	-142.16	-44.293	0.006	94.65	-10.429	0.301	-51.84
17.50	-9.332	0.342	-158.72	16.268	6.507	172.29	-44.293	0.006	58.22	-10.305	0.305	-85.61
18.00	-10.773	0.289	150.47	16.398	6.605	124.73	-44.013	0.006	22.77	-10.912	0.285	-120.38
18.50	-11.879	0.255	88.51	16.310	6.539	78.43	-44.013	0.006	-11.16	-12.146	0.247	-156.35
19.00	-11.132	0.278	22.99	16.495	6.680	29.89	-43.609	0.007	-45.88	-14.226	0.194	164.49
19.50	-9.289	0.343	-33.82	16.645	6.796	-19.03	-43.479	0.007	-82.45	-17.109	0.140	116.97
20.00	-7.836	0.406	-80.69	16.432	6.631	-67.23	-43.223	0.007	-114.76	-18.985	0.112	56.33
20.50	-7.078	0.443	-122.07	16.097	6.380	-114.99	-43.876	0.006	-149.02	-17.393	0.135	-8.93
21.00	-6.998	0.447	-162.32	15.726	6.114	-161.08	-43.876	0.006	-179.37	-14.462	0.189	-57.64
21.50	-7.416	0.426	156.08	15.444	5.919	152.40	-42.853	0.007	151.62	-12.003	0.251	-98.38
22.00	-8.363	0.382	109.87	15.704	6.099	105.40	-42.158	0.008	117.02	-10.249	0.307	-137.92
22.50	-9.391	0.339	54.50	16.211	6.465	57.04	-40.724	0.009	76.50	-9.213	0.346	-177.68
23.00	-9.304	0.343	15.31	16.483	6.670	6.64	-39.576	0.011	24.33	-9.030	0.354	140.91
23.50	-7.872	0.404	-100.07	15.909	6.243	-50.00	-42.499	0.008	-35.37	-9.254	0.345	105.41
24.00	-6.558	0.470	-174.74	14.992	5.618	-107.02	-47.744	0.004	-67.10	-8.685	0.368	69.77
24.50	-5.546	0.528	122.43	14.052	5.042	-160.62	-51.057	0.003	-70.24	-8.372	0.381	32.18
25.00	-4.939	0.566	67.01	12.600	4.266	149.39	-50.458	0.003	-80.53	-8.094	0.394	-5.43

Note: S-parameters are obtained using demo board with 50 Ohm traces at input and output.



## Biasing and Operation

The AMMP-5620 only requires a single positive supply connected to the Vd pin (2). The recommended supply voltage is 5V. The supply should be bypassed with a 0.1uF capacitor placed as close to the component as possible. The package base is the RF and DC ground connection. The biasing arrangement is shown in Figure 21.

Figure 22 shows a simplified schematic for the amplifier die. All three stages are self-biased as shown. Each stage has feedback around it to control the gain, match and performance, resulting in excellent wideband performance. Also shown are the on-chip DC blocking capacitors for both the RFin and RFout pins.

Please refer to the Absolute Maximum Ratings table for allowed DC and thermal conditions.

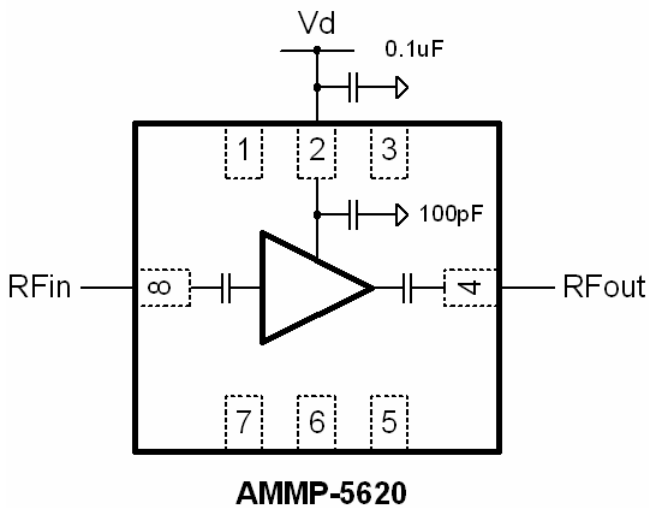

Figure 21. Typical Application.

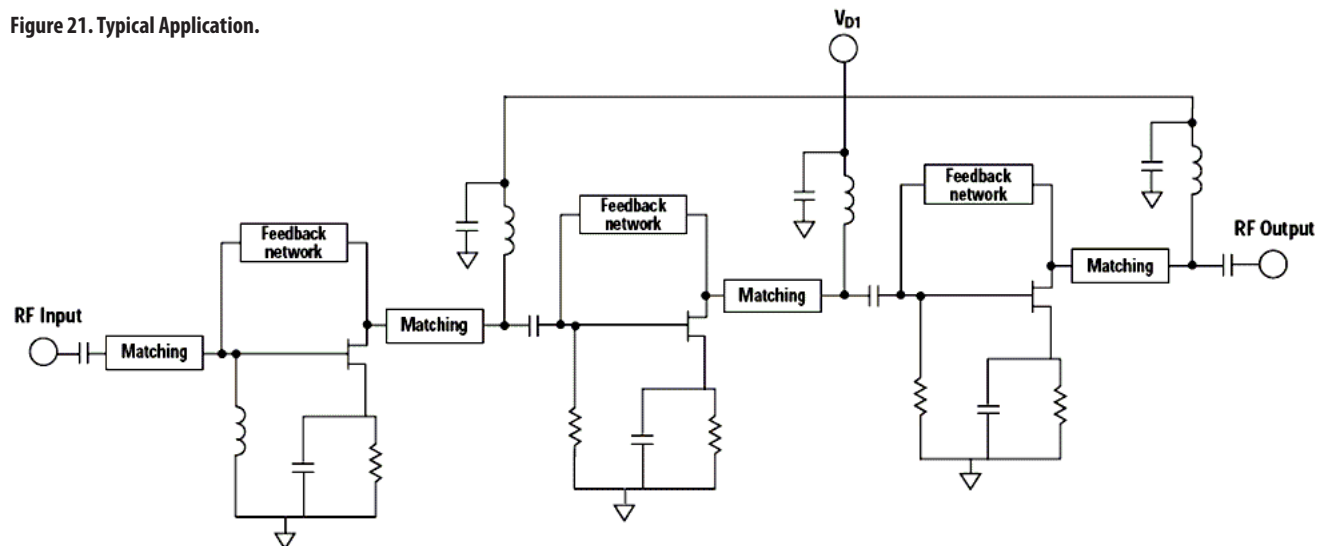

Figure 22. Simplified MMIC Schematics.

## Recommended SMT Attachment

The AMMP Packaged Devices are compatible with high volume

surface mount PCB assembly processes. The PCB material and mounting pattern, as defined in the data sheet, optimizes RF performance and is strongly recommended. An electronic drawing of the land pattern is available upon request from Avago Sales & Application Engineering.

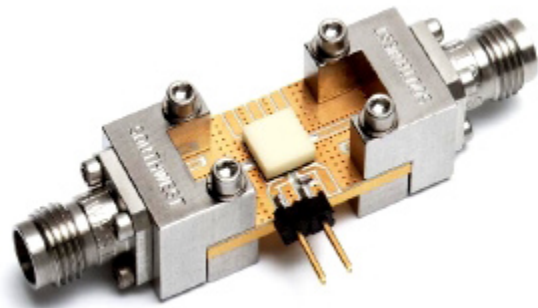

Figure 23. Demonstration Board (available upon request).

## Manual Assembly

1. Follow ESD precautions while handling packages.
2. Handling should be along the edges with tweezers.
3. Recommended attachment is conductive solder paste.  
Please see recommended solder reflow profile.  
Conductive epoxy is not recommended. Hand soldering is not recommended.
4. Apply solder paste using a stencil printer or dot placement.  
The volume of solder paste will be dependent on PCB and component layout and should be controlled to ensure consistent mechanical and electrical performance.
5. Follow solder paste and vendor's recommendations when developing a solder reflow profile. A standard profile will have a steady ramp up from room temperature to the pre-heat temperature to avoid damage due to thermal shock.
6. Packages have been qualified to withstand a peak temperature of 260°C for 20 seconds. Verify that the profile will not expose device beyond these limits.

## Outline Drawing

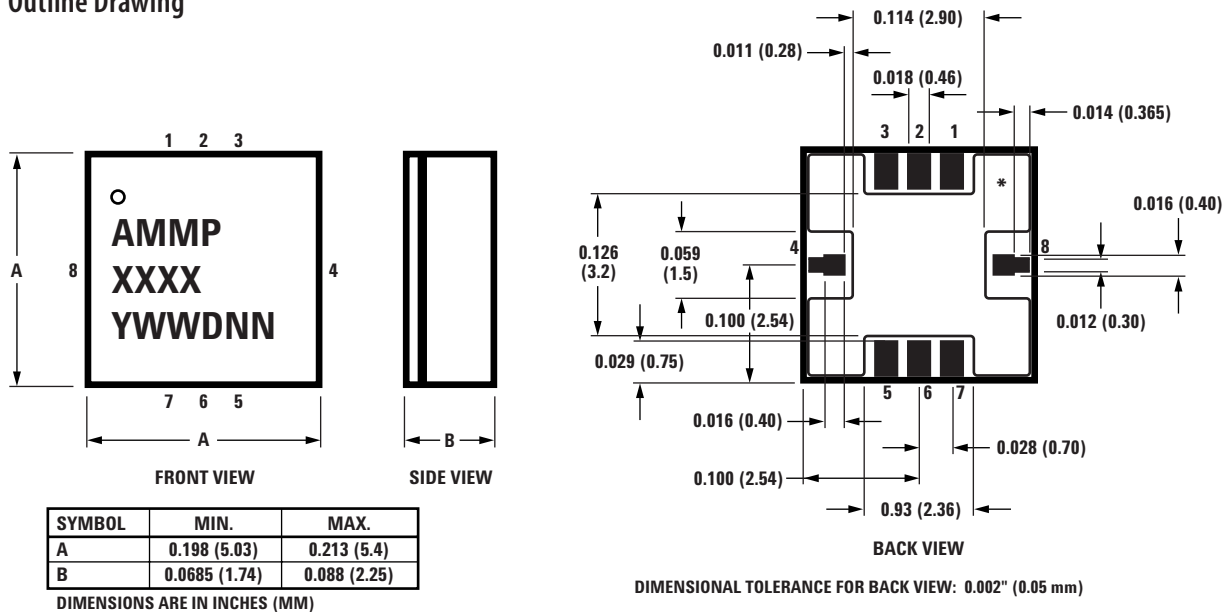

Figure 24. Outline Drawing.

## Stencil Design Guidelines

A properly designed solder screen or stencil is required to ensure optimum amount of solder paste is deposited onto the PCB pads. The recommended stencil layout is shown in Figure 26. The stencil has a solder paste deposition opening approximately 70% to 90% of the PCB pad. Reducing stencil opening can potentially generate more voids underneath. On the other hand, stencil openings larger than 100% will lead to excessive solder paste smear or bridging across the I/O pads. Considering the fact that solder paste thickness will directly affect the quality of the solder joint, a good choice is to use a laser cut stencil composed of 0.127 mm (5 mils) thick stainless steel which is capable of producing the required fine stencil outline.

The combined PCB and stencil layout is shown in Figure 27.

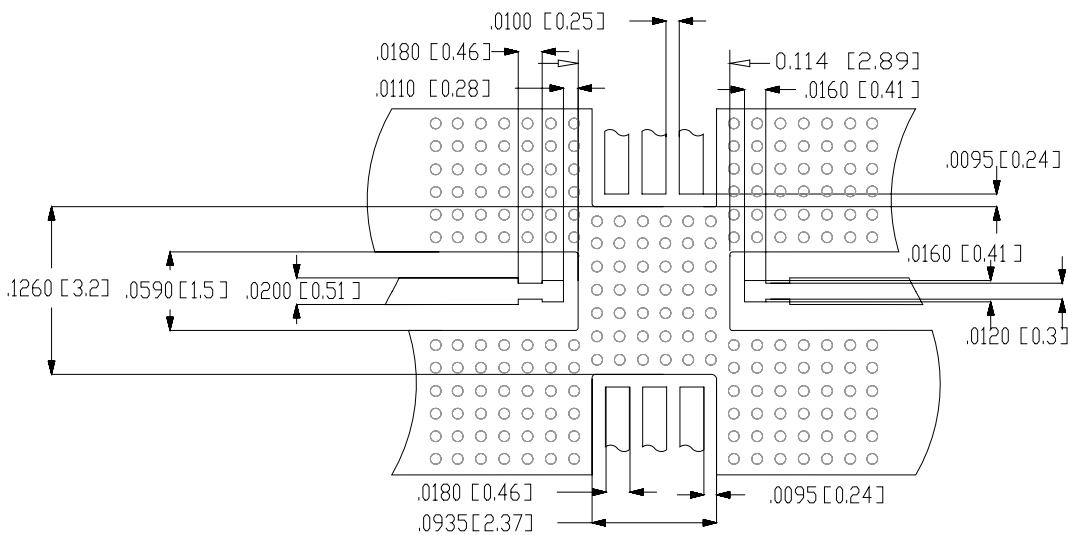

Figure 25. Suggested PCB Land Pattern and Stencil Layout

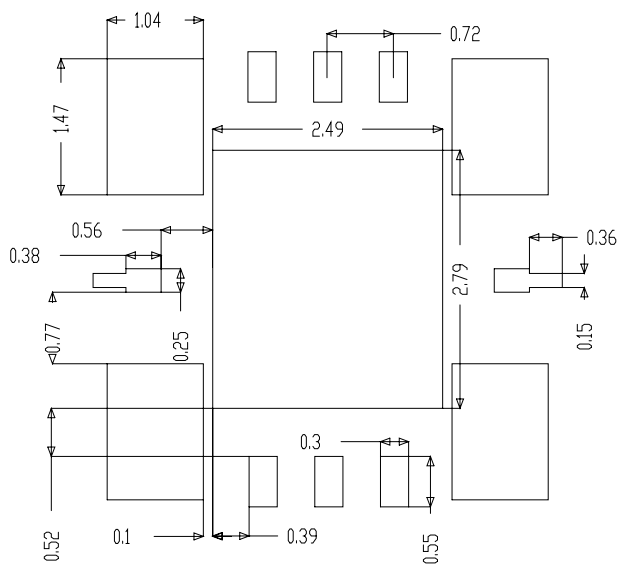

Figure 26. Stencil Outline Drawing (mm)

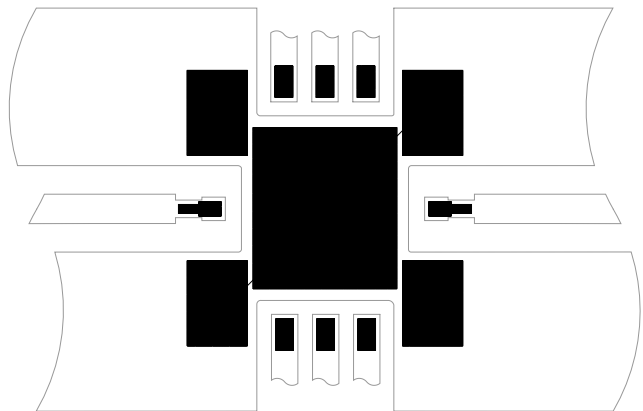
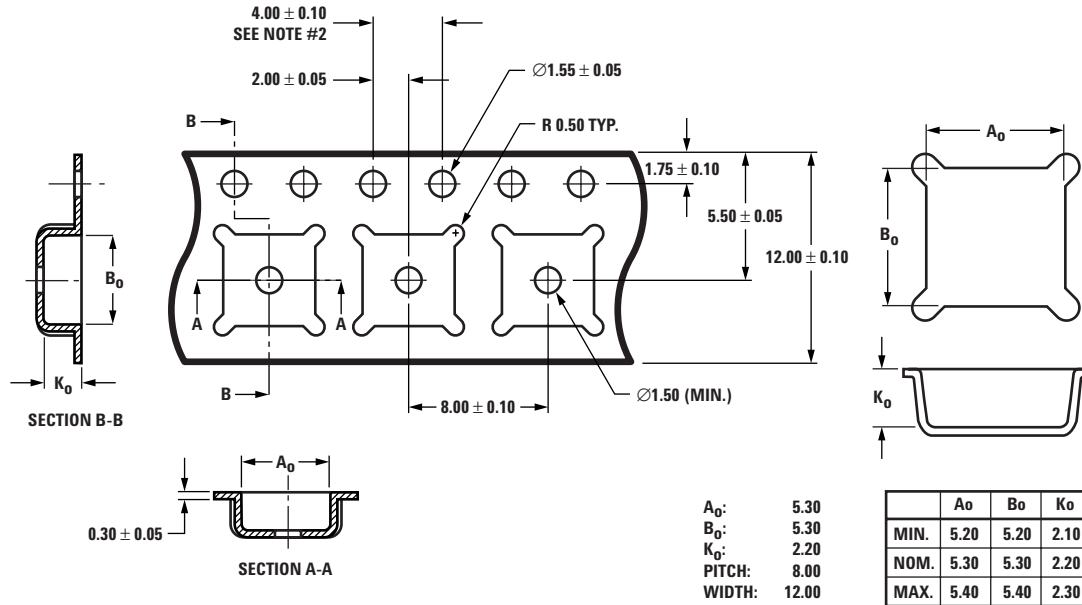

Figure 27. Combined PCB and Stencil Layout

## Carrier Tape and Pocket Dimensions



### NOTES:

1. A<sub>0</sub> AND B<sub>0</sub> MEASURED AT 0.3 mm ABOVE BASE OF POCKET.
2. 10 PITCHES CUMULATIVE TOLERANCE IS ± 0.2 mm.
3. DIMENSIONS ARE IN MILLIMETERS (mm).

## Device Orientation (Top View)

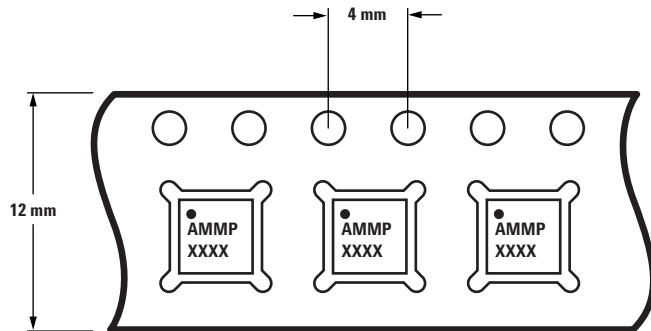

## Part Number Ordering Information

Part Number	Devices per Container	Container
AMMP-5620-BLKG	10	Antistatic Bag
AMMP-5620-TR1G	100	7" Reel
AMMP-5620-TR2G	500	7" Reel

For product information and a complete list of distributors, please go to our web site: [www.avagotech.com](http://www.avagotech.com)

Avago, Avago Technologies, and the A logo are trademarks of Avago Technologies Limited in the United States and other countries. Data subject to change. Copyright © 2008 Avago Technologies Limited. All rights reserved. Obsoletes AV01-0585EN AV02-0513EN - February 27, 2008

**AVAGO**  
TECHNOLOGIES